

CORMACH

71000 E
A.S.C. Plus

Quality Management
ISO 9001
www.dekra-seal.com



www.cormach.com

... ABOUT ANCIENT

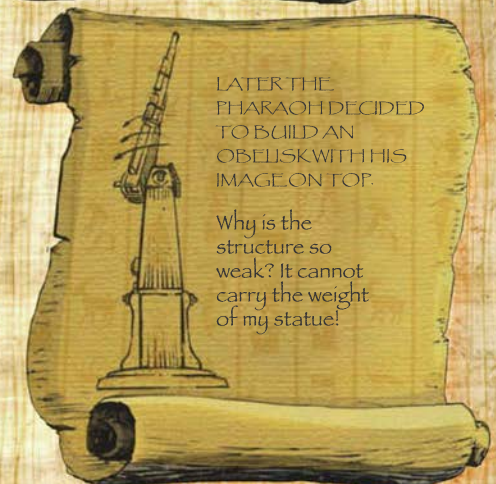
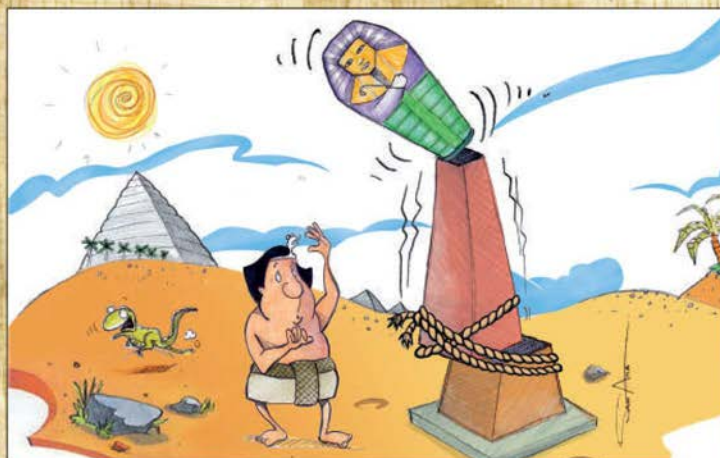
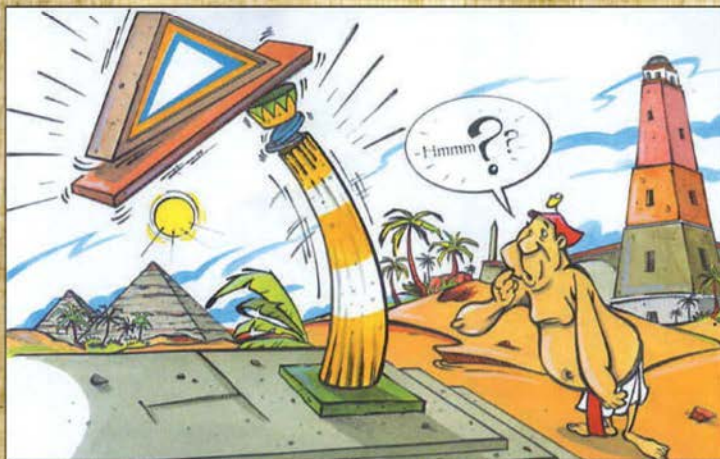
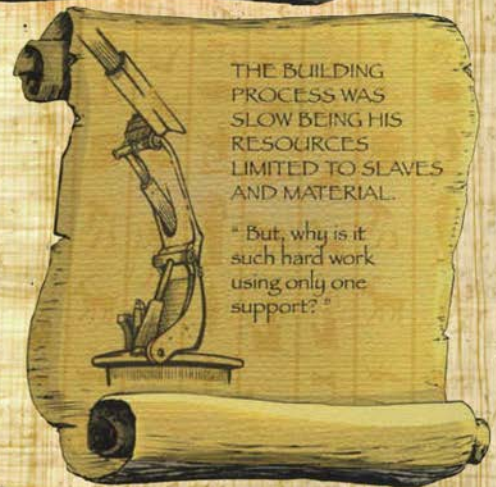

EGYPT MANUSCRIPTS

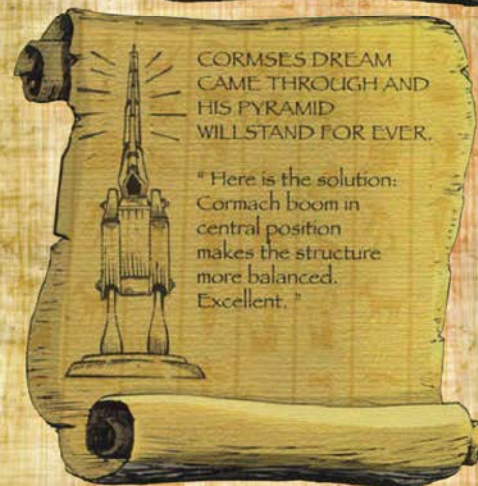
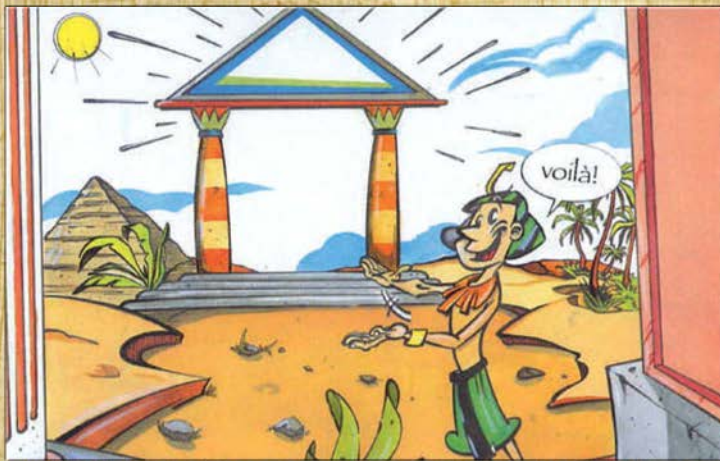
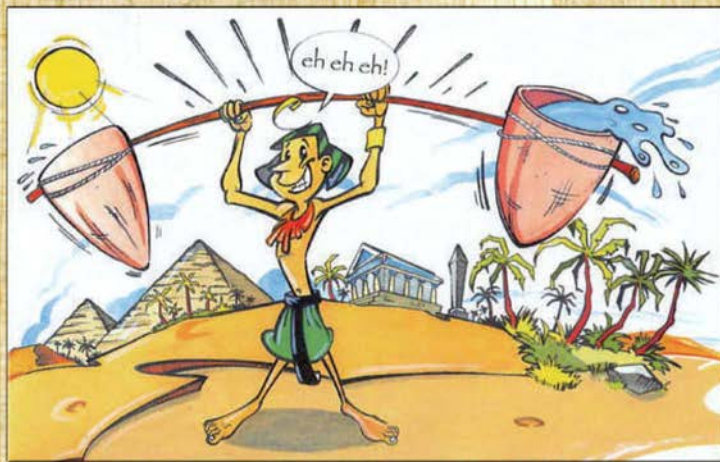
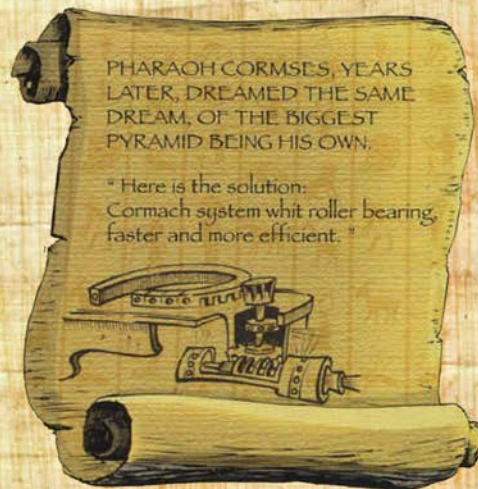

END

GORMAGH

**SCOPRI IL MONDO
GORMAGH**



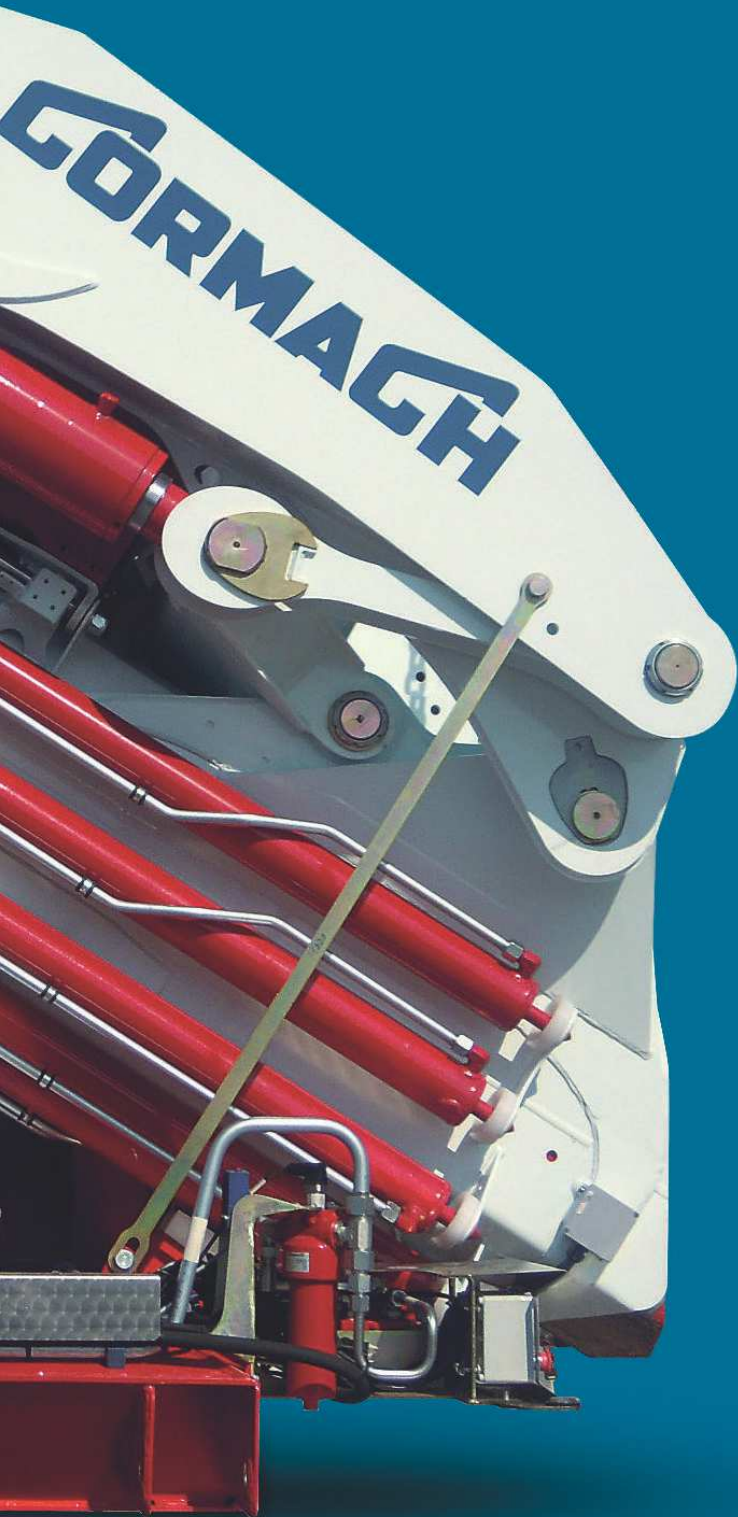



Radiocomando con Display (opzione) di serie con limitatore elettronico
Wire less remote control box with Display (option) delivered as a standard part when crane is supplied with the electronic load-limiting device.
 Funkfernsteuerung mit Bildschirm (Option) serienmäßig geliefert mit elektronischem Überlastabschaltungssystem.
 Radiocommande avec display (option) de série avec limiteur électronique



Verricello tiro diretto 4000 daN - (OPZIONE) (2500 daN con JIB)
 4000 daN (2500 daN with JIB) winch on first line - (OPTIONAL)
 Treuil de tir direct 4000 daN (2500 daN avec JIB) - (OPTION)
 4000 daN (2500 daN JIB) Winde am ersten Seil - (AUF FRAGE)
 Cabrestante tiro directo 4000 daN (2500 daN JIB) - (BAJO PEDIDO)

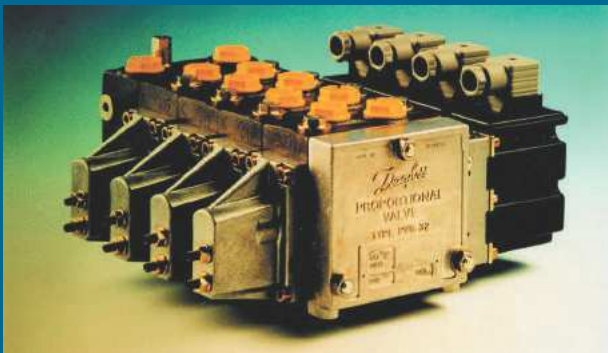

Distributore proporzionale DANFOSS
 DANFOSS proportional control bank
 Distributeur proportionnelle DANFOSS
 DANFOSS proportionale Steuerventil
 Distribuidor proporcional DANFOSS



Comandi di Emergenza degli Stabilizzatori
 Stabilizers Emergency controls
 Not Bedienung der Stützen
 Commande d'urgence de Stabilisateurs

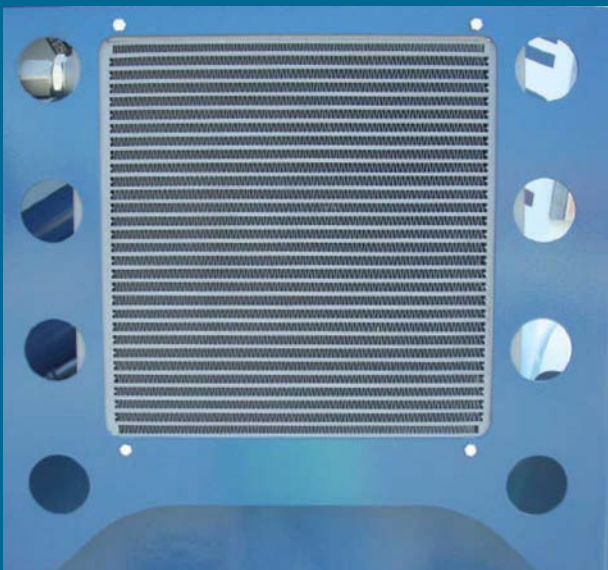

Scambiatore di calore
 Heat exchanger
 Echangeur de chaleur Ölkühler
 Refrigerador de aceite



Comandi stabilizzatori elettrici
 Electric controls of the outriggers
 Commande stabilisateurs électriques
 Abstützungen elektronisch gesteuert (oder elektronisch überwacht?)
 Mandos para estabilizadores electricos

71000 E A.S.C. Plus

Doppi cilindri di sollevamento
Double lifting cylinder
Double vérin de levage
Zwei Hubzylinder
Doble cilindros de elevacion

Angolo negativo tra 1° e 2° braccio (15 gradi)
Negative angle between 1st and 2nd boom (15 degrees)
Angle négatif entre 1ère et 2ème bras (15 degrés)
Negativ Winkel zwischen ersten und zweiten Arm (15 Grad)
Angulo negativo entre 1° y 2° brazo (15 grados)

Carter e serbatoio olio in acciaio inossidabile
Protections and oil tank in stain less steel
Schutzbleche sowie Öltank aus Edelstahl
Carters e réservoir d'huile en acier inoxydable

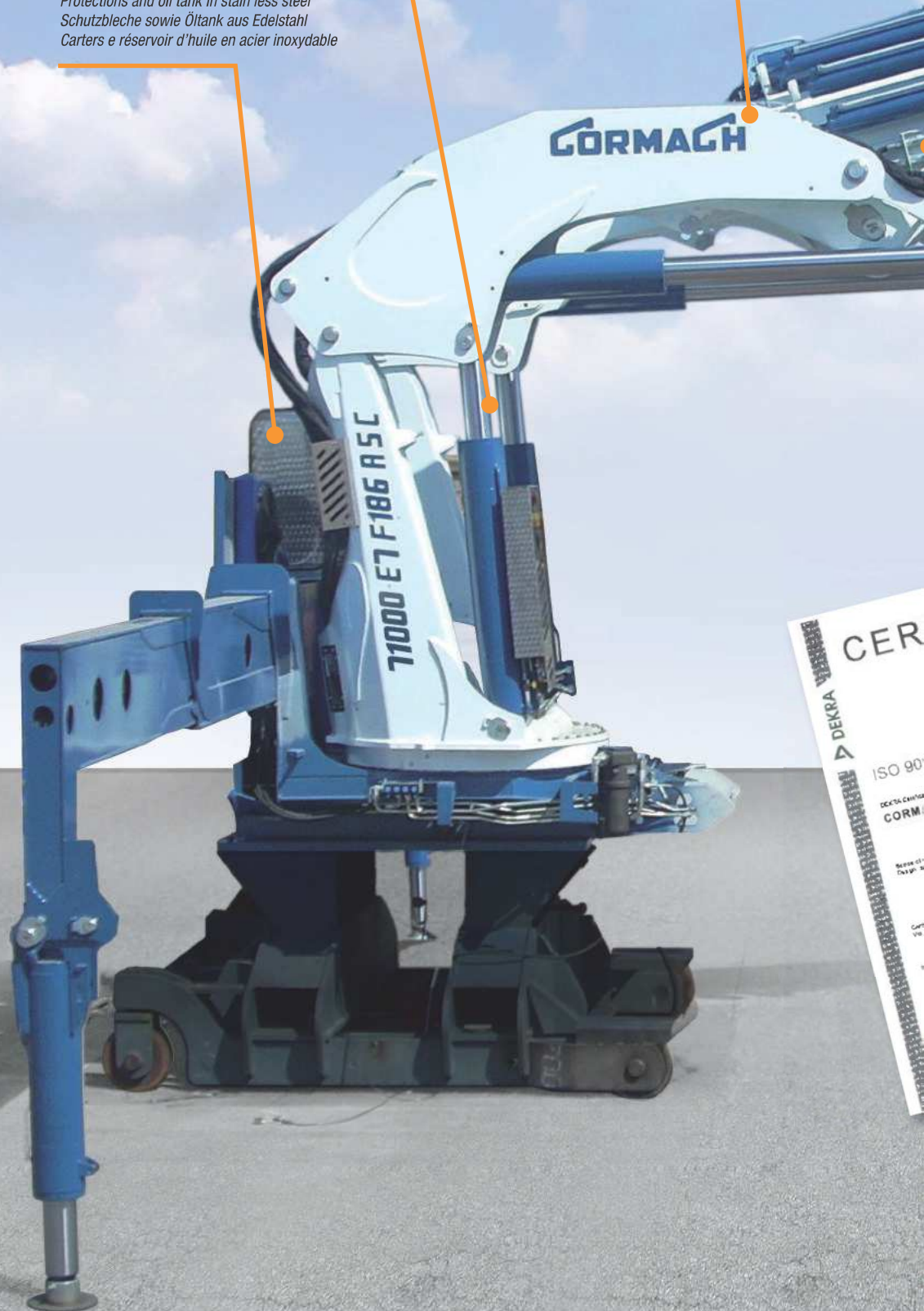

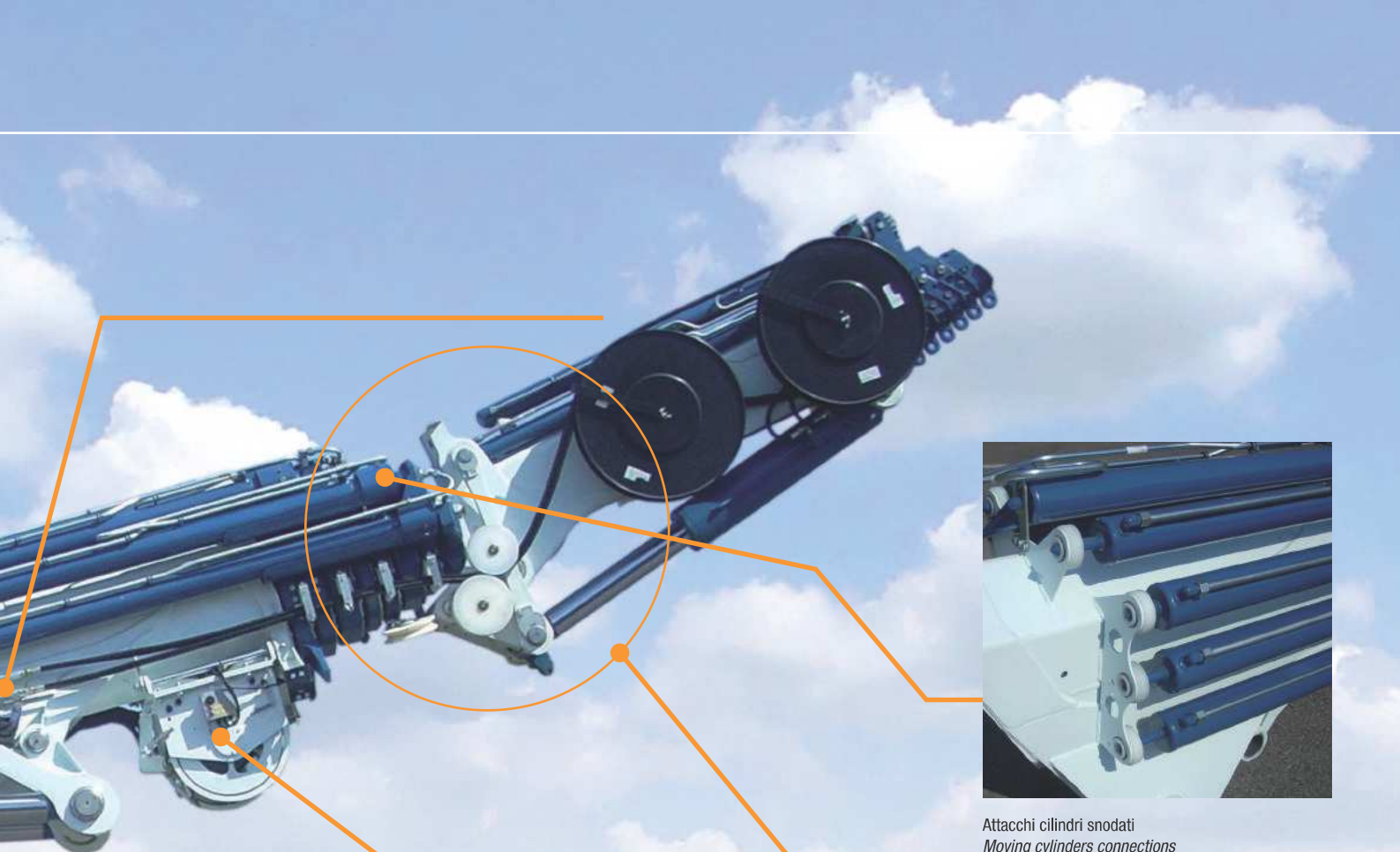

Attacchi cilindri snodati
 Moving cylinders connections
 Bewegliche Zylinder Halterungen
 Fixage de vérin basculant

Angolo negativo tra prolunghe e JIB (10 gradi)
 Negative angle between extensions and JIB (10 degrees)
 Angle négatif entre extensions et JIB (10 degrés)
 Ausleger und JIB (10 Grad)
 Angulo negativo entre prolongas y JIB (10 grados)



Verricello tiro diretto 4000 daN - (OPZIONE) (2500 daN con JIB)
 4000 daN (2500 daN with JIB) winch on first line - (OPTIONAL)
 Treuil de tir direct 4000 daN (2500 daN avec JIB) - (OPTION)
 4000 daN (2500 daN JIB) Winde am ersten Seil - (AUF FRAGE)
 Cabrestante tiro directo 4000 daN (2500 daN JIB) - (BAJO PEDIDO)



Fissaggio rapido per ganci, JIB ed accessori, sistema modulare CORMACH
 Quick disconnecting system for hooks, JIB and accessories, CORMACH modular system
 Schnell Wechselsystem für Haken, JIB und Zubehör, CORMACH Modular System
 Fixage rapide de croquet, JIB et accessoires, système modulaire CORMACH



Sezione poligonale delle prolunghe, sistema CORMACH
 The boom extension with polygonal structure, CORMACH design
 Polygonal Ausschube, CORMACH System
 Bras a structure polygonale, Système CORMACH



Articolazione con Biella e Puntone
 Articulation with link
 Articulation de bras
 Kniehebel am Knickarm
 Articulación con biela y puntal



LAMIERE
 Le gru CORMACH sono realizzate utilizzando lamiere ad altissima resistenza con tensione minima di snervamento, in funzione del modello, che può raggiungere i 1300 N*mm².

STEEL PLATES
 CORMACH cranes are produced using steel plates with high resistance with minimum yielding stress specific for each Model that can reach 1300 N*mm².

TOLES D'ACIER
 Les grues CORMACH sont produites en utilisant des toles d'acier avec haut resistance avec tension de déformation minimale spécifique pour chaque Model que peut arriver à 1300 N*mm².

STAHLKONSTRUKTION
 Das Stahlgerüst von CORMACH Kranen sind von extreme hoher Belastung bei minimalem Eigengewicht. Je nach Model wird ein Gewicht von 1300 N*mm² erreicht.

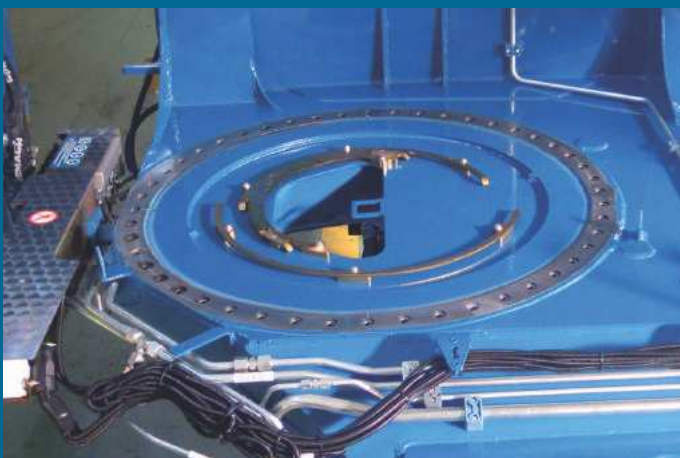

Ralla di Ø Maggiore rispetto alla concorrenza = Migliore distribuzione dei carichi
 Slew bearing with bigger Ø than the competition = Better distribution of the stresses
 Drehkranz mit einem größeren Ø als Wettbewerb = Bessere Verteilung der Belastung
 Couronne avec Ø plus important de la concurrence = plus correcte distribution de stress



Aggancio/Sgancio rapido JIB
 Quick connection and disconnection of the JIB
 Connexion rapide de JIB
 Schnellkupplung des Jib (für die Hydraulik; hydraulische Schnellkupplung)
 Enganche/desenganche rápido del JIB



CORMACH È AMICA DELL'AMBIENTE: UTILIZZO DI VERNICI ALL'ACQUA E POMPE A PORTATA VARIABILE.

Con l'utilizzo di prodotti di verniciatura all'acqua, la CORMACH può vantare un ciclo di verniciatura completamente ecologico e rispettoso dell'ambiente. Siamo infatti riusciti a ridurre le emissioni nell'atmosfera di circa il 90% grazie all'utilizzo di questa tecnologia all'avanguardia. Attualmente il ciclo di verniciatura utilizzato dalla CORMACH può vantare migliori prestazioni di protezione, resistenza, aspetto estetico e d'impatto d'ambientale. I vantaggi migliori per l'utilizzo dei prodotti di verniciatura ad acqua sono:

• Impatto ambientale ridotto

Utilizzare vernici all'acqua significa ridurre il grave problema collegato all'emissione nell'ambiente di solventi e sostanze inquinanti

• Pericolosità ridotta

Le vernici all'acqua sono esenti da sostanze infiammabili, rendendole innocue per l'operatore e per la loro conservazione in magazzino.

Le moderne gru di portata elevata, con sbracci notevoli, necessitano di un controllo molto preciso dei movimenti; pertanto vengono impiegate valvole distributrici di tipo proporzionale che erogano una portata d'olio in proporzione all'ampiezza del comando ricevuto.

La pompa a cilindrata variabile, eroga una portata che varia, in funzione di una differenza di pressione costante tra la pompa stessa e l'utenza, attraverso un segnale di pilotaggio proveniente dalla valvola distributrice. Durante il funzionamento a vuoto la pompa si posiziona nella cilindrata 0. Durante le manovre a vuoto o con carico, la pompa eroga esclusivamente la portata richiesta.

L'ottimizzazione della portata permette quindi un minor consumo di carburante, minori emissioni in atmosfera ed un notevole risparmio economico dovuto ai minori consumi.

CORMACH PRODUCTS ARE ENVIRONMENTALLY FRIENDLY WITH THE USE OF WATER BASED PAINTS AND PISTON PUMPS WITH VARIABLE DISPLACEMENT

CORMACH S.r.L., has been implementing a water base colours painting system and therefore can claim an ecologic and environment friendly painting cycle. In fact CORMACH has been able to reduce by 90% the emission of polluting substances into the atmosphere. The painting cycle adopted by CORMACH can claim the best ratio between protection, resistance, aesthetic and ambient impact.

The main advantages arising from the use water base paint are:

- Low environmental impact, the use of water-based paints contains the emission in the atmosphere of solvents and other polluting substances.
- Lowers the danger, considering the water-based paints are not flammable, reducing therefore the danger level for the user and for the stocking.

The new generation of heavy lifting cranes with long booms, need a very precise control of the movements, therefore they are equipped with proportional control valves, valves that supply a quantity of oil that is proportional to the magnitude of the activation of the different functions.

The variable displacement pump, supplies a variable flow, in function of a difference of pressure, constant between the pump itself and the activated function, through a piloting signal that comes from the control valve. When the crane runs at idle the pump positions itself on displacement 0. When a function is activated, with or without load, the pump delivers only the required flow.

Optimizing the oil flow reduces costs by reducing fuel consumption also lowering emissions to the atmosphere.

CORMACH EST SOUCIEUX DE L'ENVIRONNEMENT EN UTILISANT DES PEINTURES A L'EAU ET DES POMPES A DEBIT VARIABLE

CORMACH est aussi une société soucieuse de l'environnement. L'utilisation de peintures écologiques permet de réduire de 90% les émissions de COV dans l'atmosphère. Notre chaîne de peinture entièrement robotisée nous permet en flux continu de réaliser les étapes de grenailage, application de l'apprêt, peinture, séchage, permettant d'obtenir une qualité optimale en terme de protection et de finition.

Les avantages majeurs de la peinture à l'eau sont:

- Un impact environnemental faible: Une réduction des émissions de solvants et de substances polluantes dans l'environnement.
- Protection des opérateurs et sécurité de stockage : Les peintures à l'eau ne contiennent pas de substances inflammables.

Les grues de nouvelle génération de capacité élevée, avec très de très long bras, ont besoin d'un contrôle très précis des mouvements. Pour le garantir on utilise des distributeurs proportionnels avec un débit d'huile proportionné à la commande sélectionnée.

La pompe à débit variable distribue un débit qui

change en fonction de la différence de pression constante entre la pompe et le mouvement, par un signal de pilotage qui vient de la soupape de distribution. Sans l'utilisation de la grue, la pompe est positionnée sur la cylindrée 0. Pendant les manœuvres à vide ou avec la charge, la pompe débite seulement le débit demandé.

L'optimisation du débit permet donc une économie de carburant et réduit les émissions polluantes dans l'atmosphère.

CORMACH IST UMWELTFREUNDLICH: EINSATZ VON LACKEN AUF WASSERBASIS UND VON HYDRAULISCHEN VERSTELLPUMPEN

CORMACH S.r.L. hat eine Lackieranlage für Lacke auf Wasserbasis in Betrieb genommen und kann daher einen ökologischen und umweltfreundlichen Lackierzyklus bieten. Tatsächlich war CORMACH in der Lage, die Emission von Feinstaub und anderen schädlichen Substanzen um ca. 90% zu reduzieren. Der von CORMACH eingesetzte Lackierzyklus liefert das beste Verhältnis zwischen Schutz, Widerstandsfähigkeit, Ästhetik und Umwelteinfluss.

Die Hauptvorteile der Lackierung auf Wasserbasis sind:

- Geringerer Umwelteinfluss, der Einsatz von wasserlöslichen Lacken verhindert die Emission von Lösemitteln und anderen gefährlichen Substanzen.
- Verminderung von Gefahren, da Lacke auf Wasserbasis nicht entzündlich sind und damit die Risiken bei Lagerhaltung und Anwendung wesentlich geringer sind.

Die neue Generation der Schwerlastkrane mit langen Teleskoparmen benötigt eine sehr genaue hydraulische Steuerung. Hierfür sind diese Krane mit Proportional-Ventilen ausgestattet. Dies sind Steuerventile, welche den einzelnen Funktionen eine Ölmenge zur Verfügung stellt, die genau proportional zur Auslenkung der jeweiligen Steuerhebel ist.

Die automatisch verstellbare Hydraulikpumpe liefert einen variablen Ölstrom abhängig von den Druckunterschieden im System, der von einem Pilotsignal des jeweiligen Steuerventils geregelt wird. Wenn der Kran steht, wird die Hydraulikpumpe auf „0-Förderung“ geregelt. Wenn eine Kranbewegung angesteuert wird, mit oder ohne Last, wird nur der jeweils benötigte Ölstrom gefördert.

Die Optimierung der Hydraulikanlage reduziert den Kraftstoffverbrauch, vermindert Lärm- und Abgasemissionen und spart so zusätzlich noch bares Geld!

CORMACH SERVICE



La completa soddisfazione del cliente è il nostro obiettivo primario.

Grazie al nostro ufficio di ricerca & sviluppo, alle nostre squadre mobili ed ai nostri centri di assistenza qualificati, siamo in grado di risolvere in maniera solerte ed efficace qualsiasi problematica.

I pezzi di ricambio sono sempre reperibili presso il nostro magazzino e presso i nostri rivenditori.

Grazie a questi sforzi che la CORMACH ha raggiunto nei anni, un livello di qualità e affidabilità assoluti.

CORMACH SERVICE

The satisfaction of the client is our primer target. Thanks to our technical department, to our mobile service teams and to our service centres, we are in the condition solve all possible problems, rapidly and satisfactory.

The availability of original spare-parts is always warranted, all spare parts are always available ex our or our dealer stocks.

It is thanks to this that CORMACH reached, through year of evolution, a high level of quality and reliability

CORMACH SERVICE

Notre objectif principal est 100% de satisfaction client.

Notre bureau d'études, nos centres de SAV, nos équipes mobiles sont à la disposition de notre clientèle pour répondre, dans un laps de temps le plus court, à toute sollicitation.

Un stock permanent de pièces détachées est

disponible chez nous et chez nos revendeurs, afin de vous assurez le maximum de réactivité.

Merci à ces efforts que le CORMACH atteints dans les années, un niveau de qualité et de fiabilité absolue.

CORMACH SERVICE

Die Zufriedenheit unserer Kunden ist das oberste Ziel.

Dank unserer technischen Abteilung, unserer

eigenen Service-Teams und unserer Service-Zentren sind wir in der Lage, sämtliche Probleme schnell und umfassend zu lösen.

Die Verfügbarkeit von Original-Ersatzteilen ist jederzeit garantiert, sowohl von unserem Zentrallager als auch von den Ersatzteillagern unserer Vertragspartner.

Aus diesen Gründen erreichte CORMACH durch Jahre der Entwicklung den hohen Qualitäts- und Zuverlässigkeitsstandard.



71000 E A.S.C. Plus





FGM car

70 80
AN 06512
ECOLARI
MAN 128BF
COSTRUZIONE BERNINORCHI - FROSINONE - ITALY
PH. 0331 477532200 - WWW.FGMCAR.IT

71000 E A.S.C. Plus





71000 E A.S.C. Plus





71000 E A.S.C. Plus

71000 E2

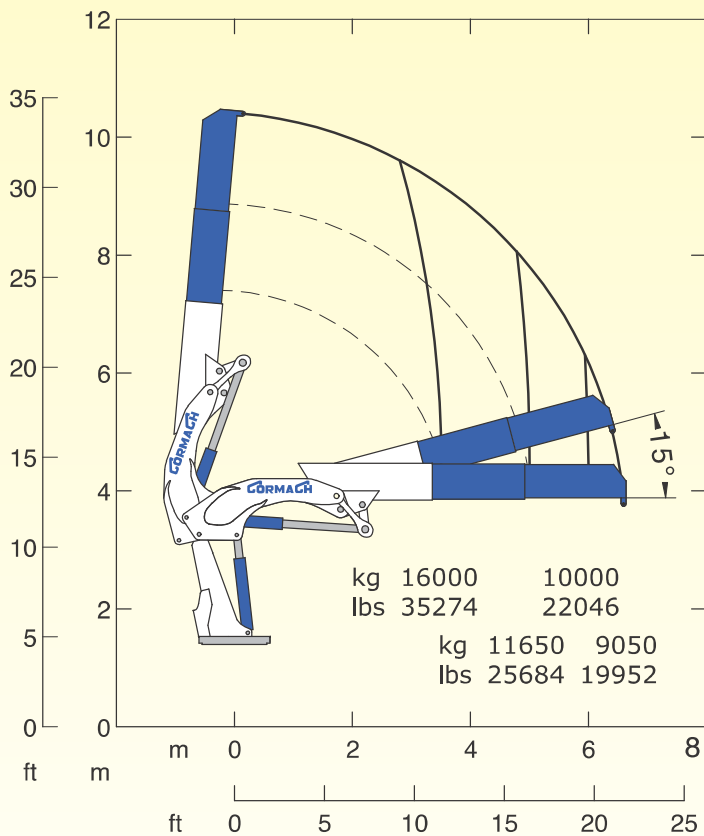

71000 E3

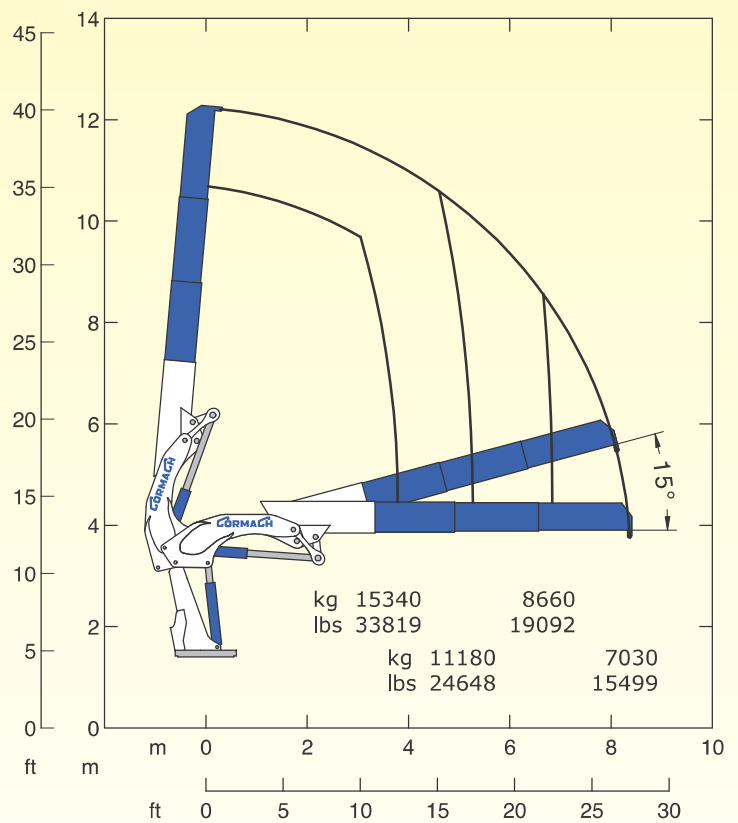

STANDARD



OPTIONAL

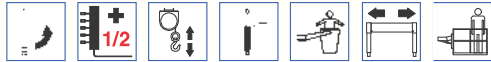

STANDARD



OPTIONAL



E2	E2		E3	E3
71200 daN*m	515089 Lb*ft	Momento statico massimo al perno torretta – Max. static moment at the turret pin Moment statique max. a l'axe de la tourelle – Max. statisches ubmoment am kransaulenboizen	71200 daN*m	515089 Lb*ft
6.64 m	21' 9"	Sbraccio idraulico – Hydraulic boom lenght Longueur du bras hydraulique – Hydraulisch reichweite	8.39 m	27' 6"
		Sbraccio con prolunghe manuali – Boom length with manual extension Longueur du bras avec rallonges manuelles - Auslegerlänge		
7100 daN*m	51364 Lb*ft	Coppia di rotazione – Slew torque – Moment de rotation – Drehmoment	7100 daN*m	51364 Lb*ft
90 sec 360°	90 sec 360°	Tempo di rotazione – Slewing speed – Temp de rotation – Schwenkgeschwindigkeit	90 sec 360°	90 sec 360°
3625+2875mm	11' 11"+9' 5"	Uscita stabilizzatori – Outriggers extension – Sortie de bequilles – Breite der Abstützung	3625+2875mm	11' 11"+9' 5"
8850 mm	29' 0"	Larghezza stabilizzatori – Outriggers width – Largeur des bequilles – Gesamtbreite der Abstützung	8850 mm	29' 0"
1645 mm	5' 5"	Lunghezza – Length – Longueur - Gesamtbreite	1645 mm	5' 5"
2550 mm	8' 4"	Larghezza – Width – Largeur - Breite	2550 mm	8' 4"
2611 mm	8' 7"	Altezza – Height – Hauteur - Höhe	2611 mm	8' 7"
5973 kg	13168 lbs	Peso (senza olio e montaggio) – Weight (without oil and fitting) Poids (sans huile et montage – Gewicht (ohne Öl und ohne)	6251 kg	13781 lbs
100 l/min	26 us gal/min	Portata pompa – Pump delivery – Capacité de la pompe - Pumpenleistung	100 l/min	26 us gal/min
320 bar	4550 psi	Pressione (*) – Pressure (*) – Pression (*) - Druck (*)	320 bar	4550 psi
235 l	62 us gal	Capacità serbatoio olio – Oil tank capacity – Capacité du réservoir de l'huile – Öl tank inhalt	235 l	62 us gal

(*) Consigliata, (°) Recommended, (°) Reconnué, (°) Empfohlen.

71000 E4

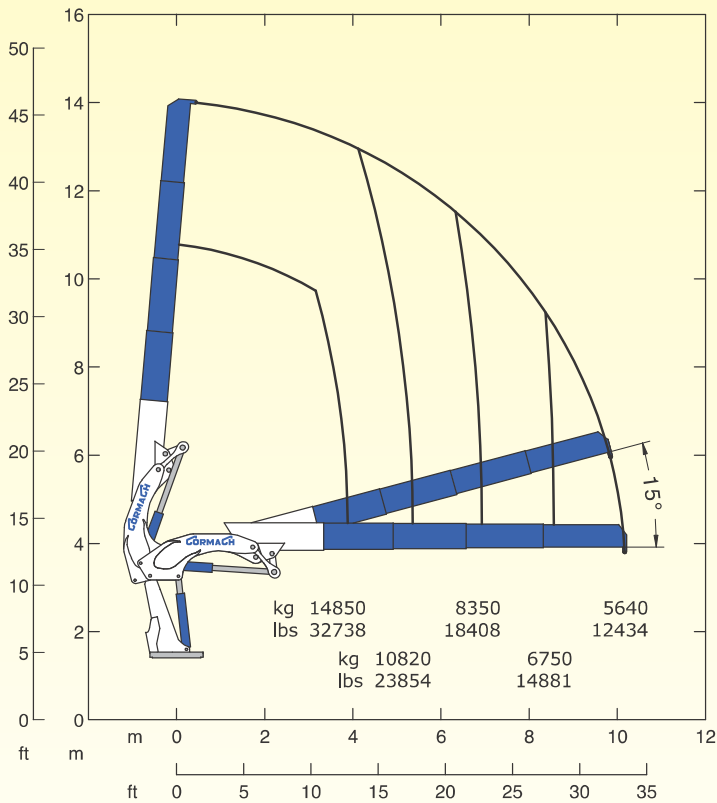

71000 E5

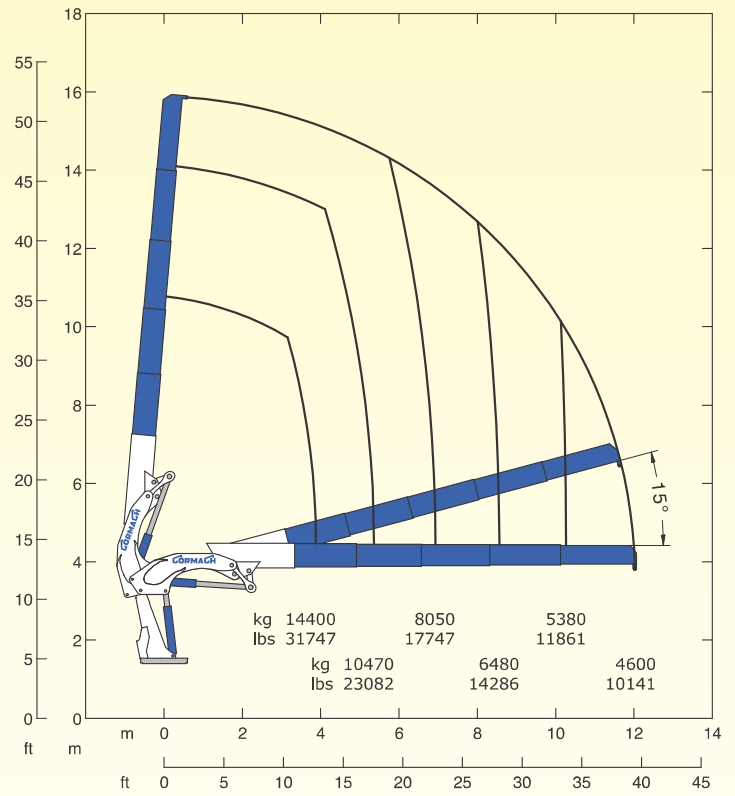

STANDARD



OPTIONAL

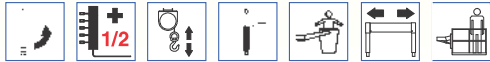

STANDARD



OPTIONAL



E4	E4		E5	E5
71200 daN*m	515089 Lb*ft	Momento statico massimo al perno torretta – Max. static moment at the turret pin Moment statique max. a l'axe de la tourelle – Max. statisches ubmoment am kransaulenboizen	71200 daN*m	515089 Lb*ft
10.20 m	33' 6"	Sbraccio idraulico – Hydraulic boom lenght Longueur du bras hydraulique – Hydraulic reichweite	12.05 m	39' 6"
		Sbraccio con prolunghe manuali – Boom length with manual extension Longueur du bras avec rallonges manuelles - Auslegerlänge		
7100 daN*m	51364 Lb*ft	Coppia di rotazione – Slew torque – Moment de rotation – Drehmoment	7100 daN*m	51364 Lb*ft
90 sec 360°	90 sec 360°	Tempo di rotazione – Slewing speed – Temp de rotation – Schwenkgeschwindigkeit	90 sec 360°	90 sec 360°
3625+2875mm	11' 11"+9' 5"	Uscita stabilizzatori – Outriggers extension – Sortie de bequilles – Breite der Abstützung	3625+2875mm	11' 11"+9' 5"
8850 mm	29' 0"	Larghezza stabilizzatori – Outriggers width – Largeur des bequilles – Gesamtbreite der Abstützung	8850 mm	29' 0"
1645 mm	5' 5"	Lunghezza – Length – Longueur - Gesamtbreite	1645 mm	5' 5"
2550 mm	8' 4"	Larghezza – Width – Largeur - Breite	2550 mm	8' 4"
2611 mm	8' 7"	Altezza – Height – Hauteur - Höhe	2611 mm	8' 7"
6489 kg	14305 lbs	Peso (senza olio e montaggio) – Weight (without oil and fitting) Poids (sans huile et montage – Gewicht (ohne Öl und ohne)	6724 kg	14825 lbs
100 l/min	26 us gal/min	Portata pompa – Pump delivery – Capacité de la pompe - Pumpenleistung	100 l/min	26 us gal/min
320 bar	4550 psi	Pressione (*) – Pressure (*) – Pression (*) - Druck (*)	320 bar	4550 psi
235 l	62 us gal	Capacità serbatoio olio – Oil tank capacity – Capacité du réservoir de l'huile – Öl tank inhalt	235 l	62 us gal

71000 E A.S.C. Plus

71000 E6

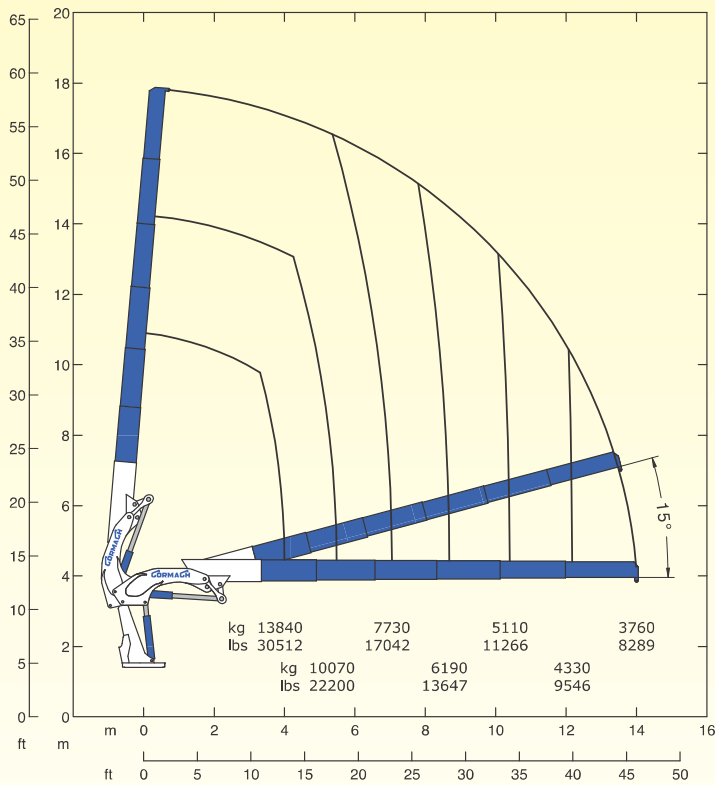

71000 E7

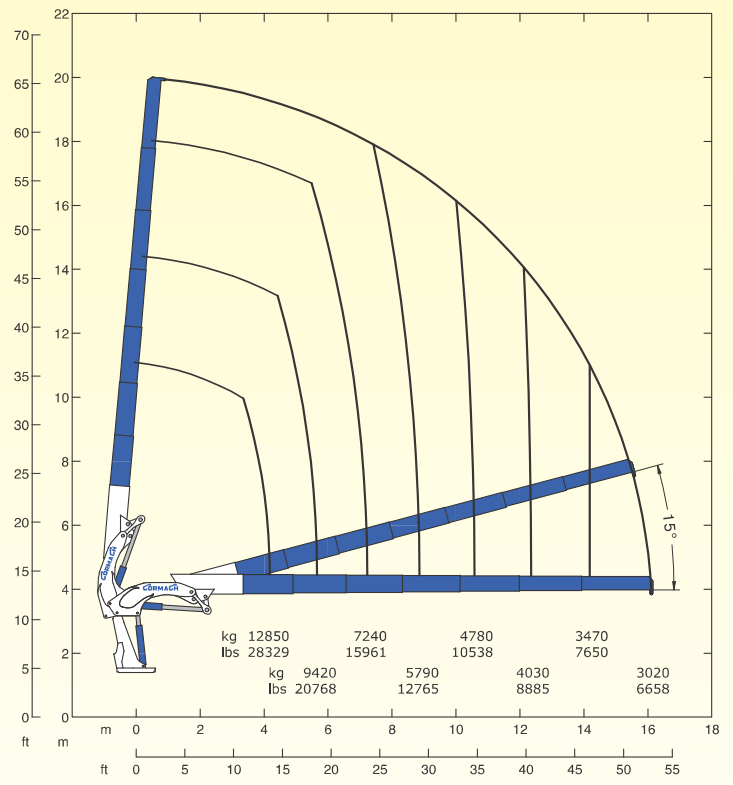

STANDARD



OPTIONAL

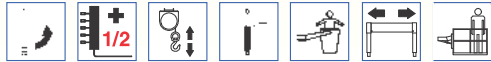

STANDARD



OPTIONAL



E6	E6		E7	E7
71200 daN*m	515089 Lb*ft	Momento statico massimo al perno torretta – Max. static moment at the turret pin Moment statique max. a l'axe de la tourelle – Max. statisches ubmoment am kransaulenbolzen	71200 daN*m	515089 Lb*ft
14.00 m	46' 0"	Sbraccio idraulico – Hydraulic boom length Longueur du bras hydraulique – Hydraulic reichweite	16.17 m	53' 1"
		Sbraccio con prolunghe manuali – Boom length with manual extension Longueur du bras avec rallonges manuelles - Auslegerlänge		
7100 daN*m	51364 Lb*ft	Coppia di rotazione – Slew torque – Moment de rotation – Drehmoment	7100 daN*m	51364 Lb*ft
90 sec 360°	90 sec 360°	Tempo di rotazione – Slewing speed – Temp de rotation – Schwenkgeschwindigkeit	90 sec 360°	90 sec 360°
3625+2875mm	11' 11"+9' 5"	Uscita stabilizzatori – Outriggers extension – Sortie de bequilles – Breite der Abstützung	3625+2875mm	11' 11"+9' 5"
8850 mm	29' 0"	Larghezza stabilizzatori – Outriggers width – Largeur des bequilles – Gesamtbreite der Abstützung	8850 mm	29' 0"
1645 mm	5' 5"	Lunghezza – Length – Longueur - Gesamtbreite	1645 mm	5' 5"
2550 mm	8' 4"	Larghezza – Width – Largeur - Breite	2550 mm	8' 4"
2611 mm	8' 7"	Altezza – Height – Hauteur - Höhe	2611 mm	8' 7"
6963 kg	15350 lbs	Peso (senza olio e montaggio) – Weight (without oil and fitting) Poids (sans huile et montage – Gewicht (ohne Oil und ohne)	7178 kg	15825 lbs
100 l/min	26 us gal/min	Portata pompa – Pump delivery – Capacité de la pompe - Pumpenleistung	100 l/min	26 us gal/min
320 bar	4550 psi	Pressione (*) – Pressure (*) – Pression (*) - Druck (*)	320 bar	4550 psi
235 l	62 us gal	Capacità serbatoio olio – Oil tank capacity – Capacité du réservoir de l'huile – Öl tank inhalt	235 l	62 us gal

71000 E8

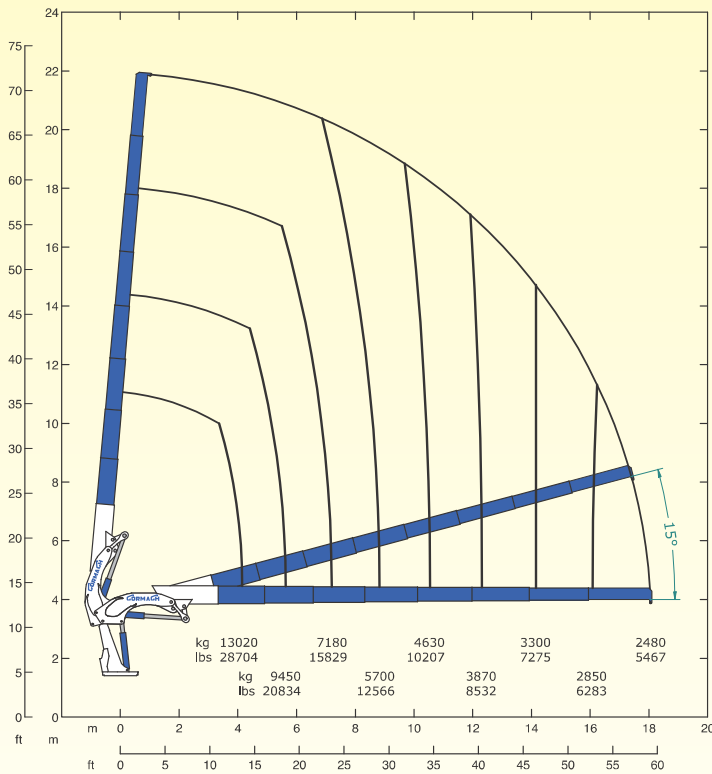

71000 E9

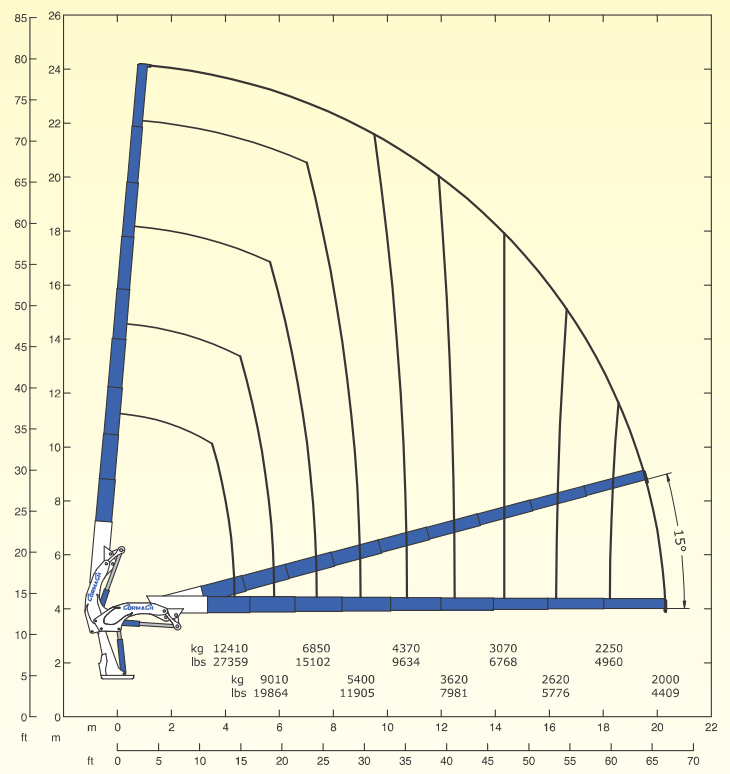

STANDARD



OPTIONAL

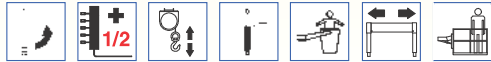

STANDARD



OPTIONAL



E8	E8		E9	E9
71200 daN*m	515089 Lb*ft	Momento statico massimo al perno torretta – Max. static moment at the turret pin Moment statique max. a l'axe de la tourelle – Max. statisches ubmoment am kransaulenbolzen	71200 daN*m	515089 Lb*ft
18.06 m	59' 3"	Sbraccio idraulico – Hydraulic boom length Longueur du bras hydraulique – Hydraulic reichweite	20.30 m	66' 7"
		Sbraccio con prolunghe manuali – Boom length with manual extension Longueur du bras avec rallonges manuelles - Auslegerlänge		
7100 daN*m	51364 Lb*ft	Coppia di rotazione – Slew torque – Moment de rotation – Drehmoment	7100 daN*m	51364 Lb*ft
90 sec 360°	90 sec 360°	Tempo di rotazione – Slewing speed – Temp de rotation – Schwenkgeschwindigkeit	90 sec 360°	90 sec 360°
3625+2875mm	11' 11"+9' 5"	Uscita stabilizzatori – Outriggers extension – Sortie de bequilles – Breite der Abstützung	3625+2875mm	11' 11"+9' 5"
8850 mm	29' 0"	Larghezza stabilizzatori – Outriggers width – Largeur des bequilles – Gesamtbreite der Abstützung	8850 mm	29' 0"
1645 mm	5' 5"	Lunghezza – Length – Longueur - Gesamtbreite	1645 mm	5' 5"
2550 mm	8' 4"	Larghezza – Width – Largeur - Breite	2550 mm	8' 4"
2611 mm	8' 7"	Altezza – Height – Hauteur - Höhe	2611 mm	8' 7"
7408 kg	16331 lbs	Peso (senza olio e montaggio) – Weight (without oil and fitting) Poids (sans huile et montage – Gewicht (ohne Oil und ohne)	7626 kg	16812 lbs
100 l/min	26 us gal/min	Portata pompa – Pump delivery – Capacité de la pompe - Pumpenleistung	100 l/min	26 us gal/min
320 bar	4550 psi	Pressione (*) – Pressure (*) – Pression (*) - Druck (*)	320 bar	4550 psi
235 l	62 us gal	Capacità serbatoio olio – Oil tank capacity – Capacité du réservoir de l'huile – Öl tank inhalt	235 l	62 us gal

71000 E A.S.C. Plus

71000 E11

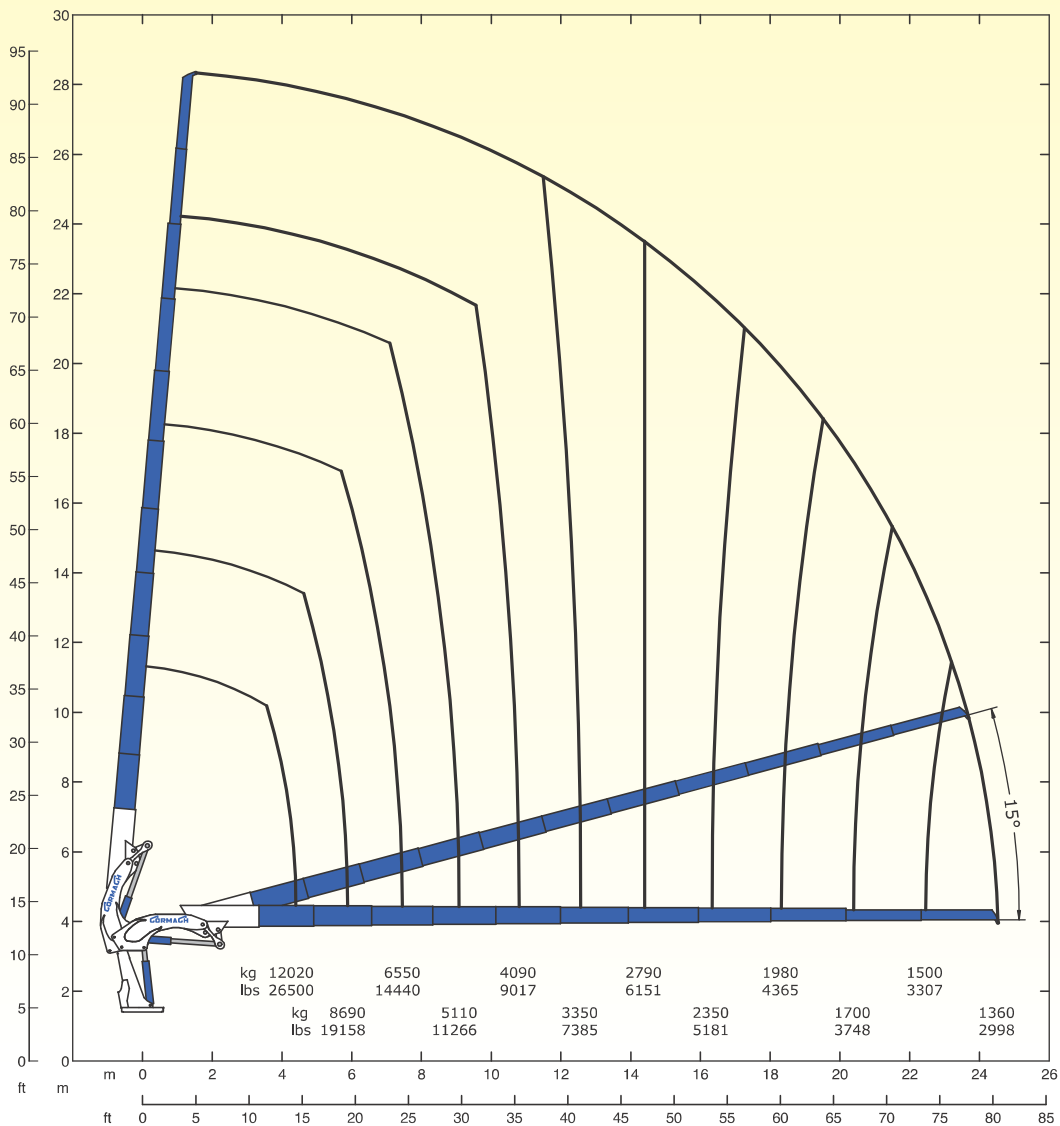

E11	E11	
71200 daN*m	515089 Lb*ft	Momento statico massimo al perno torretta – Max. static moment at the turret pin Moment statique max. a l'axe de la tourelle – Max. statisches ubmoment am kran Saulenbolzen
24.50 m	80' 5"	Sbraccio idraulico – Hydraulic boom length Longueur du bras hydraulique – Hydraulic reichweite
		Sbraccio con prolunghe manuali – Boom length with manual extension Longueur du bras avec rallonges manuelles - Auslegerlänge
7100 daN*m	51364 Lb*ft	Coppia di rotazione – Slew torque – Moment de rotation – Drehmoment
90 sec 360°	90 sec 360°	Tempo di rotazione – Slewing speed – Temp de rotation – Schwenkgeschwindigkeit
3625+2875mm	11' 11"+9' 5"	Uscita stabilizzatori – Outriggers extension – Sortie de bequilles – Breite der Abstützung
8850 mm	29' 0"	Larghezza stabilizzatori – Outriggers width – Largeur des bequilles – Gesamtbreite der Abstützung
1645 mm	5' 5"	Lunghezza – Length – Longueur – Gesamtbreite
2550 mm	8' 4"	Larghezza – Width – Largeur - Breite
2611 mm	8' 7"	Altezza – Height – Hauteur - Höhe
7914 kg	17447 lbs	Peso (senza olio e montaggio) – Weight (without oil and fitting) Poids (sans huile et montage – Gewicht (ohne Öl und ohne)
100 l/min	26 us gal/min	Portata pompa – Pump delivery – Capacité de la pompe - Pumpenleistung
320 bar	4550 psi	Pressione (*) – Pressure (*) – Pression (*) - Druck (*)
235 l	62 us gal	Capacità serbatoio olio – Oil tank capacity – Capacité du réservoir de l'huile – Öl tank inhalt

STANDARD



OPTIONAL

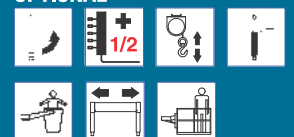

(*) Consigliata, (*) Recommended, (*) Recommandé, (*) Empfohlen.

71000 E11

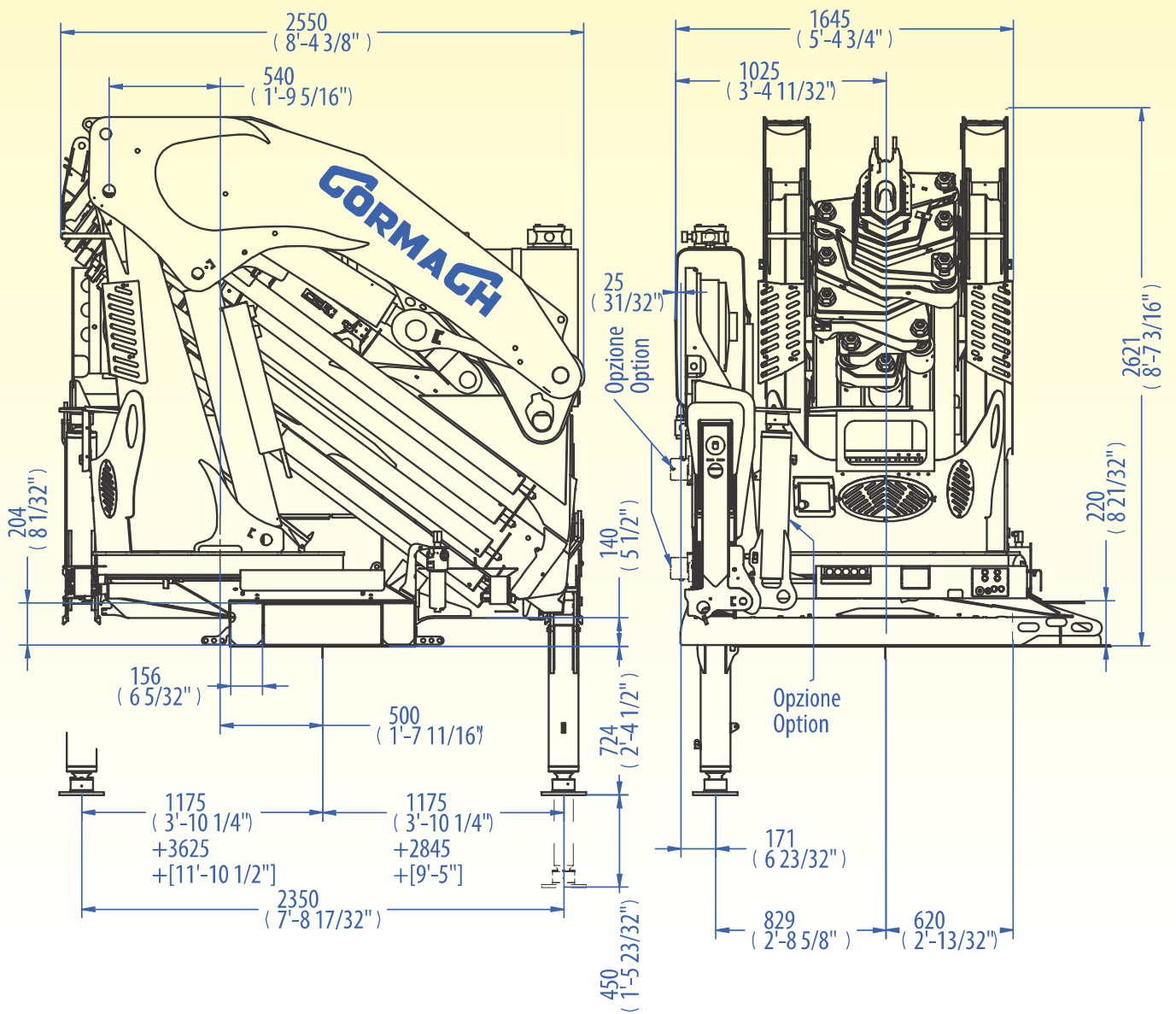

71000 E A.S.C. Plus

71000 E7F182

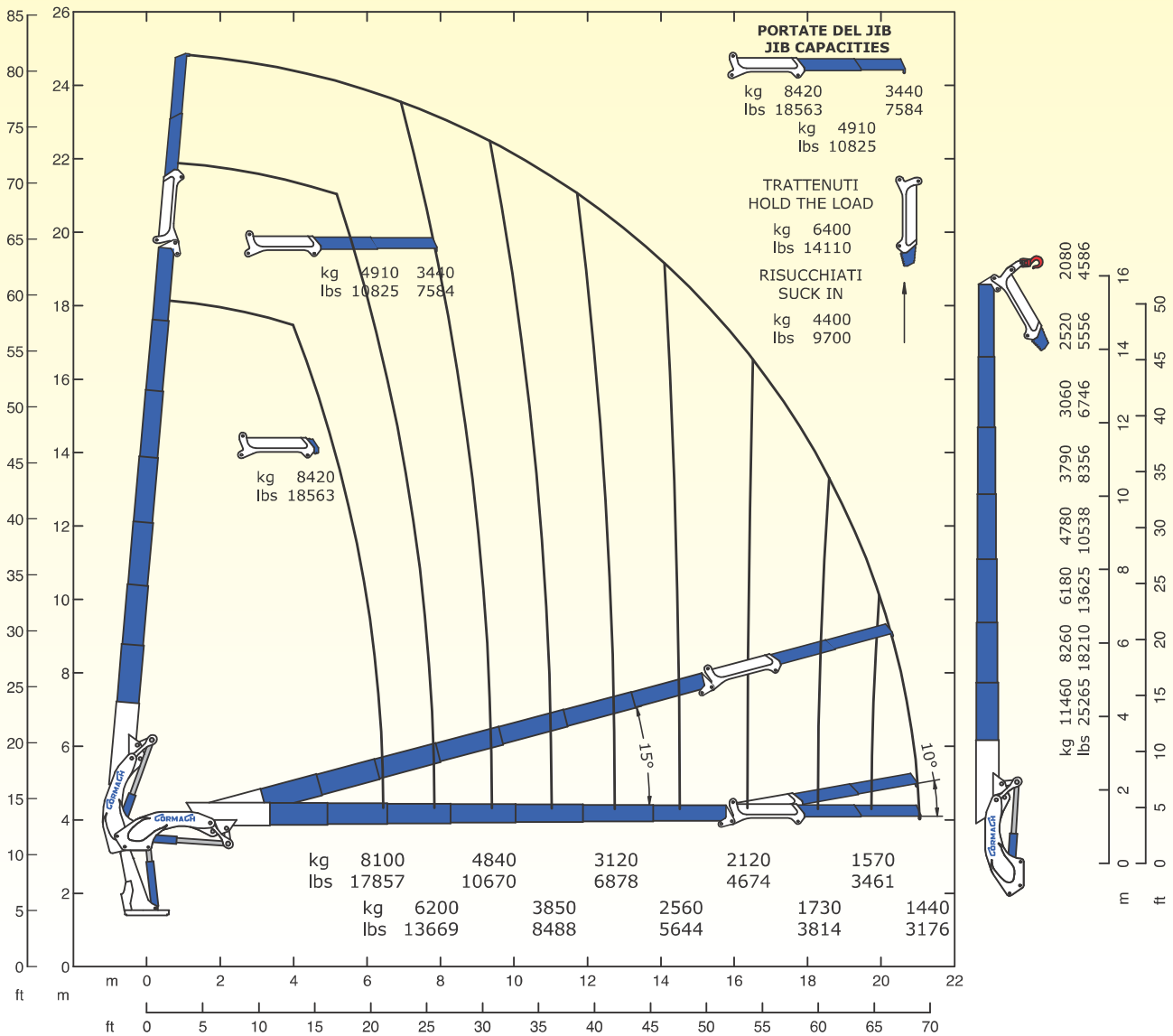

E7F182	E7F182	
71200 daN*m	515089 Lb*ft	Momento statico massimo al perno torretta – Max. static moment at the turret pin Moment statique max. a l'axe de la tourelle – Max. statisches ubmoment am kransaulenbolzen
21.27 m	69' 9"	Sbraccio idraulico – Hydraulic boom length Longueur du bras hydraulique – Hydraulic reichweite
		Sbraccio con prolunghe manuali – Boom length with manual extension Longueur du bras avec rallonges manuelles - Auslegerlänge
7100 daN*m	51364 Lb*ft	Coppia di rotazione – Slew torque – Moment de rotation – Drehmoment
90 sec 360°	90 sec 360°	Tempo di rotazione – Slewing speed – Temp de rotation – Schwenkgeschwindigkeit
3625+2875mm	11' 11"+9' 5"	Uscita stabilizzatori – Outriggers extension – Sortie de bequilles – Breite der Abstützung
8850 mm	29' 0"	Larghezza stabilizzatori – Outriggers width – Largeur des bequilles – Gesamtbreite der Abstützung
1645 mm	5' 5"	Lunghezza – Length – Longueur – Gesamtbreite
2550 mm	8' 4"	Larghezza – Width – Largeur - Breite
2940 mm	9' 8"	Altezza – Height – Hauteur - Höhe
8196 kg	18069 lbs	Peso (senza olio e montaggio) – Weight (without oil and fitting) Poids (sans huile et montage – Gewicht (ohne Oil und ohne)
100 l/min	26 us gal/min	Portata pompa – Pump delivery – Capacité de la pompe - Pumpenleistung
320 bar	4550 psi	Pressione (*) – Pressure (*) – Pression (*) - Druck (*)
235 l	62 us gal	Capacità serbatoio olio – Oil tank capacity – Capacité du réservoir de l'huile – Öl tank inhalt

STANDARD



OPTIONAL

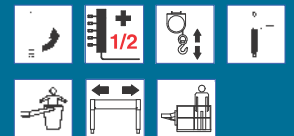

(*) Consigliata, (*) Recommended, (*) Reconnué, (*) Empfohlen.

71000 E7F183

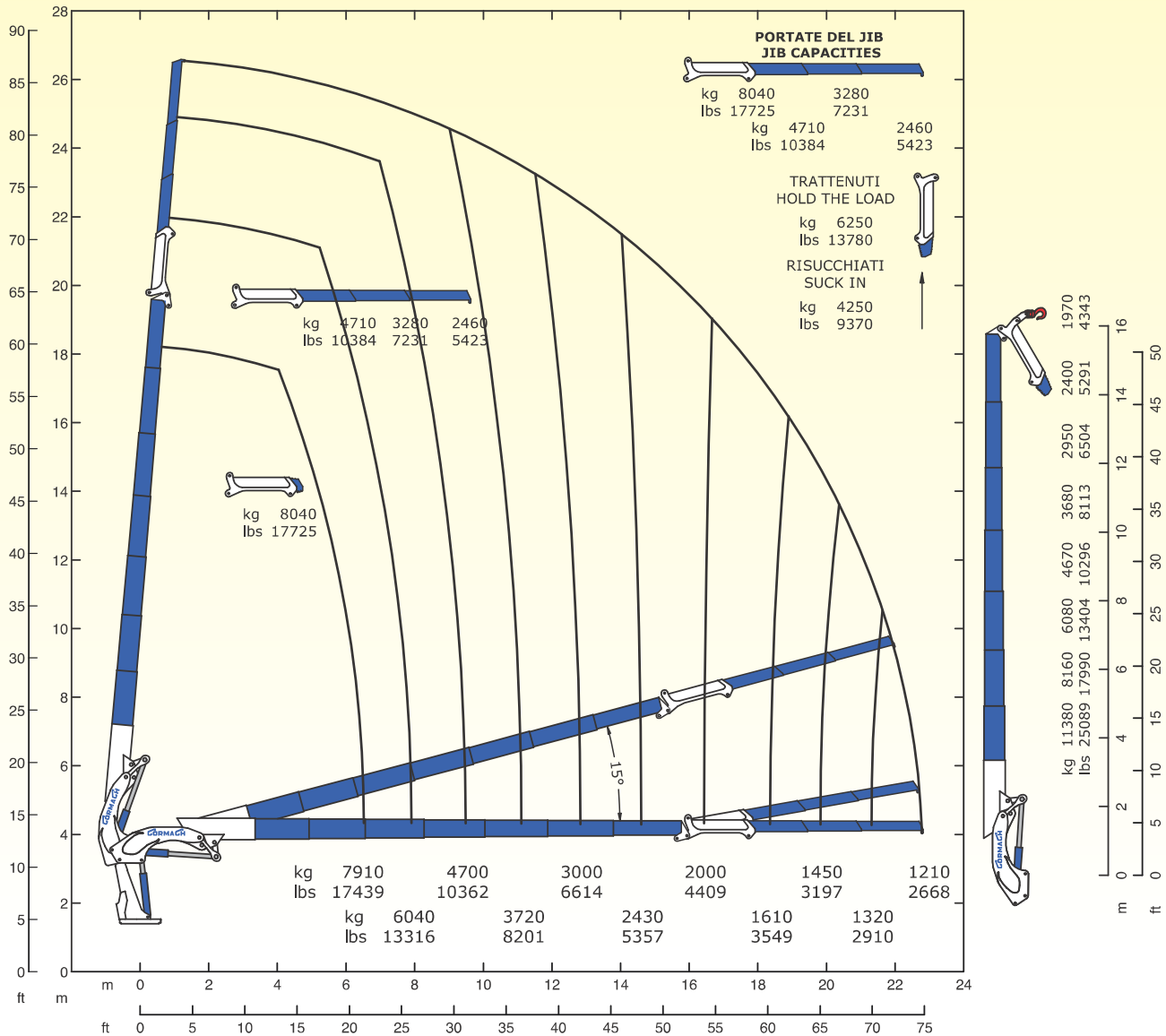

E7F183	E7F183	
71200 daN*m	515089 Lb*ft	Momento statico massimo al perno torretta – Max. static moment at the turret pin Moment statique max. a l'axe de la tourelle – Max. statisches ubmoment am kransaulenbolzen
23.00 m	75' 6"	Sbraccio idraulico – Hydraulic boom length Longueur du bras hydraulique – Hydraulic reichweite
		Sbraccio con prolunghe manuali – Boom length with manual extension Longueur du bras avec rallonges manuelles - Auslegerlänge
7100 daN*m	51364 Lb*ft	Coppia di rotazione – Slew torque – Moment de rotation – Drehmoment
90 sec 360°	90 sec 360°	Tempo di rotazione – Slewing speed – Temp de rotation – Schwenkgeschwindigkeit
3625+2875mm	11' 11"+9' 5"	Uscita stabilizzatori – Outriggers extension – Sortie de bequilles – Breite der Abstützung
8850 mm	29' 0"	Larghezza stabilizzatori – Outriggers width – Largeur des bequilles – Gesamtbreite der Abstützung
1645 mm	5' 5"	Lunghezza – Length – Longueur – Gesamtbreite
2550 mm	8' 4"	Larghezza – Width – Largeur - Breite
2940 mm	9' 8"	Altezza – Height – Hauteur - Höhe
8316 kg	18334 lbs	Peso (senza olio e montaggio) – Weight (without oil and fitting) Poids (sans huile et montage – Gewicht (ohne Oil und ohne)
100 l/min	26 us gal/min	Portata pompa – Pump delivery – Capacité de la pompe - Pumpenleistung
320 bar	4550 psi	Pressione (*) – Pressure (*) – Pression (*) - Druck (*)
235 l	62 us gal	Capacità serbatoio olio – Oil tank capacity – Capacité du réservoir de l'huile – Öl tank inhalt

STANDARD

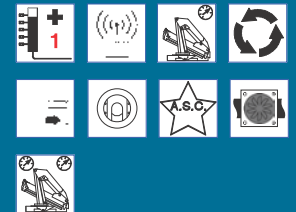

OPTIONAL

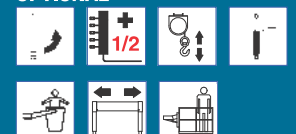

71000 E A.S.C. Plus

71000 E7F184

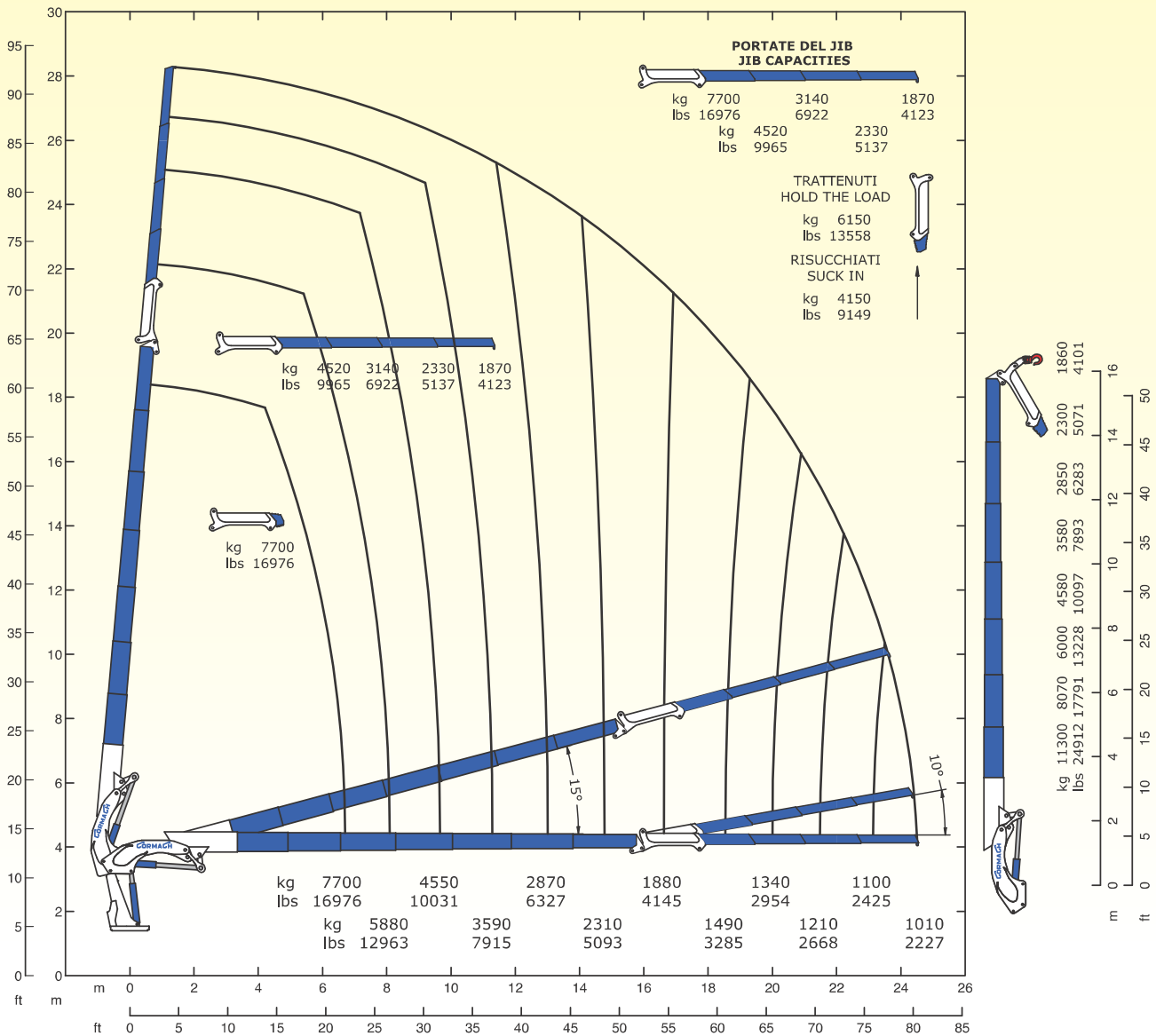

E7F184	E7F184	
71200 daN*m	515089 Lb*ft	Momento statico massimo al perno torretta – Max. static moment at the turret pin Moment statique max. a l'axe de la tourelle – Max. statisches ubmoment am kransaulenbolzen
24.73 m	81' 2"	Sbraccio idraulico – Hydraulic boom length Longueur du bras hydraulique – Hydraulic reichweite
		Sbraccio con prolunghe manuali – Boom length with manual extension Longueur du bras avec rallonges manuelles - Auslegerlänge
7100 daN*m	51364 Lb*ft	Coppia di rotazione – Slew torque – Moment de rotation – Drehmoment
90 sec 360°	90 sec 360°	Tempo di rotazione – Slewing speed – Temp de rotation – Schwenkgeschwindigkeit
3625+2875mm	11' 11"+9' 5"	Uscita stabilizzatori – Outriggers extension – Sortie de bequilles – Breite der Abstützung
8850 mm	29' 0"	Larghezza stabilizzatori – Outriggers width – Largeur des bequilles – Gesamtbreite der Abstützung
1645 mm	5' 5"	Lunghezza – Length – Longueur - Gesamtbreite
2550 mm	8' 4"	Larghezza – Width – Largeur - Breite
2940 mm	9' 8"	Altezza – Height – Hauteur - Höhe
8431 kg	18587 lbs	Peso (senza olio e montaggio) – Weight (without oil and fitting) Poids (sans huile et montage – Gewicht (ohne Oil und ohne)
100 l/min	26 us gal/min	Portata pompa – Pump delivery – Capacité de la pompe - Pumpenleistung
320 bar	4550 psi	Pressione (*) – Pressure (*) – Pression (*) - Druck (*)
235 l	62 us gal	Capacità serbatoio olio – Oil tank capacity – Capacité du réservoir de l'huile – Öl tank inhalt

STANDARD

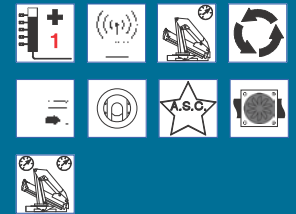

OPTIONAL

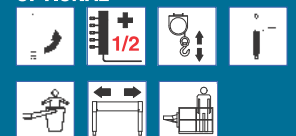

(*) Consigliata, (*) Recommended, (*) Recommandé, (*) Empfohlen.

71000 E7F185

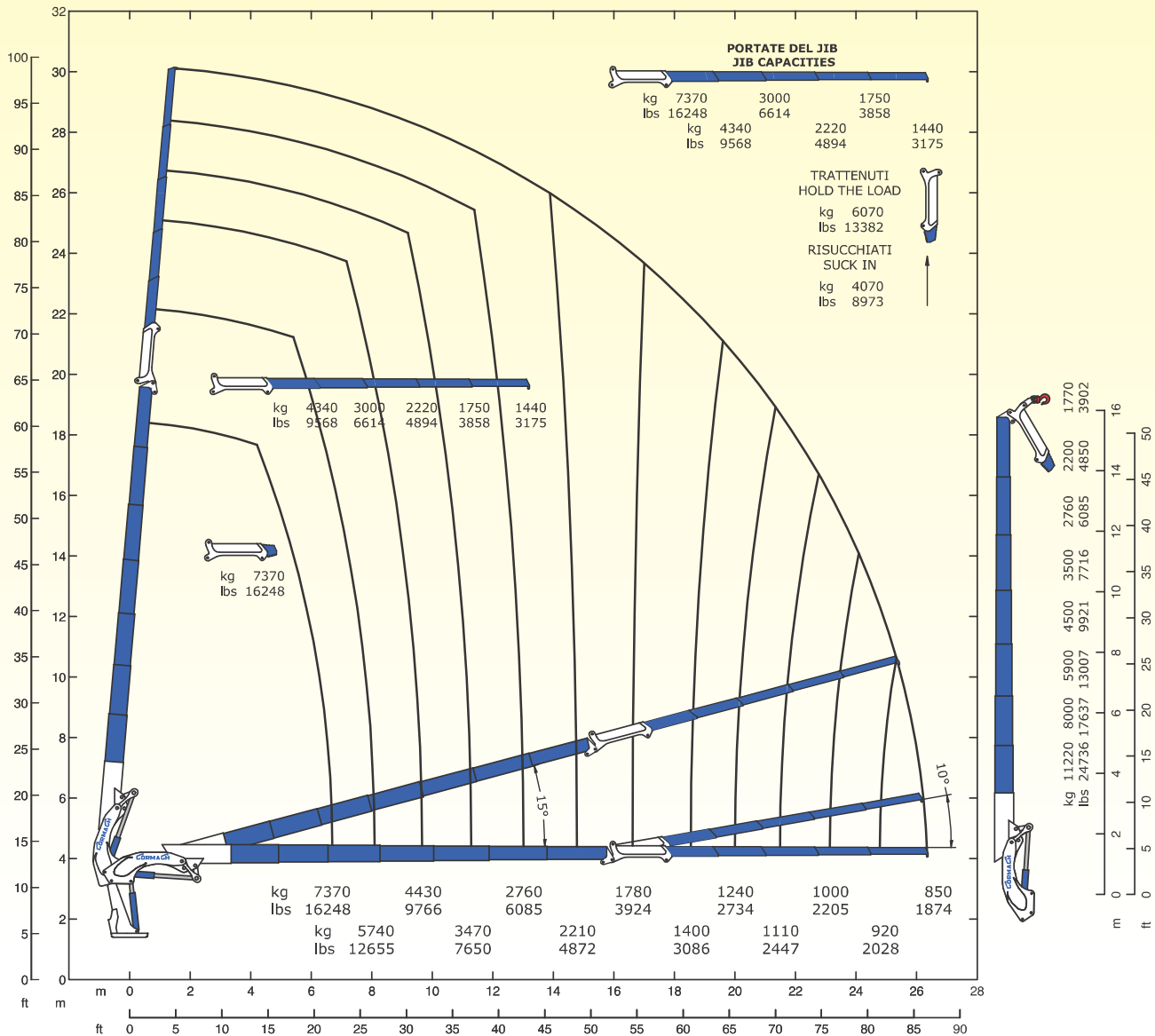

E7F185	E7F185	
71200 daN*m	515089 Lb*ft	Momento statico massimo al perno torretta – Max. static moment at the turret pin Moment statique max. a l'axe de la tourelle – Max. statisches ubmoment am kransaulenbolzen
26.57 m	87' 2"	Sbraccio idraulico – Hydraulic boom length Longueur du bras hydraulique – Hydraulic reichweite
		Sbraccio con prolunghe manuali – Boom length with manual extension Longueur du bras avec rallonges manuelles – Auslegerlänge
7100 daN*m	51364 Lb*ft	Coppia di rotazione – Slew torque – Moment de rotation – Drehmoment
90 sec 360°	90 sec 360°	Tempo di rotazione – Slewing speed – Temp de rotation – Schwenkgeschwindigkeit
3625+2875mm	11' 11"+9' 5"	Uscita stabilizzatori – Outriggers extension – Sortie de bequilles – Breite der Abstützung
8850 mm	29' 0"	Larghezza stabilizzatori – Outriggers width – Largeur des bequilles – Gesamtbreite der Abstützung
1645 mm	5' 5"	Lunghezza – Length – Longueur – Gesamtbreite
2550 mm	8' 4"	Larghezza – Width – Largeur – Breite
2940 mm	9' 8"	Altezza – Height – Hauteur – Höhe
8526 kg	18797 lbs	Peso (senza olio e montaggio) – Weight (without oil and fitting) Poids (sans huile et montage – Gewicht (ohne Oil und ohne)
100 l/min	26 us gal/min	Portata pompa – Pump delivery – Capacité de la pompe – Pumpenleistung
320 bar	4550 psi	Pressione (*) – Pressure (*) – Pression (*) – Druck (*)
235 l	62 us gal	Capacità serbatoio olio – Oil tank capacity – Capacité du réservoir de l'huile – Öl tank inhalt

STANDARD

-
-
-
-
-
-
-
-

OPTIONAL

-
-
-
-
-
-

(*) Consigliata, (*) Recommended, (*) Reconnardé, (*) Empfohlen.

71000 E A.S.C. Plus

71000 E7F186

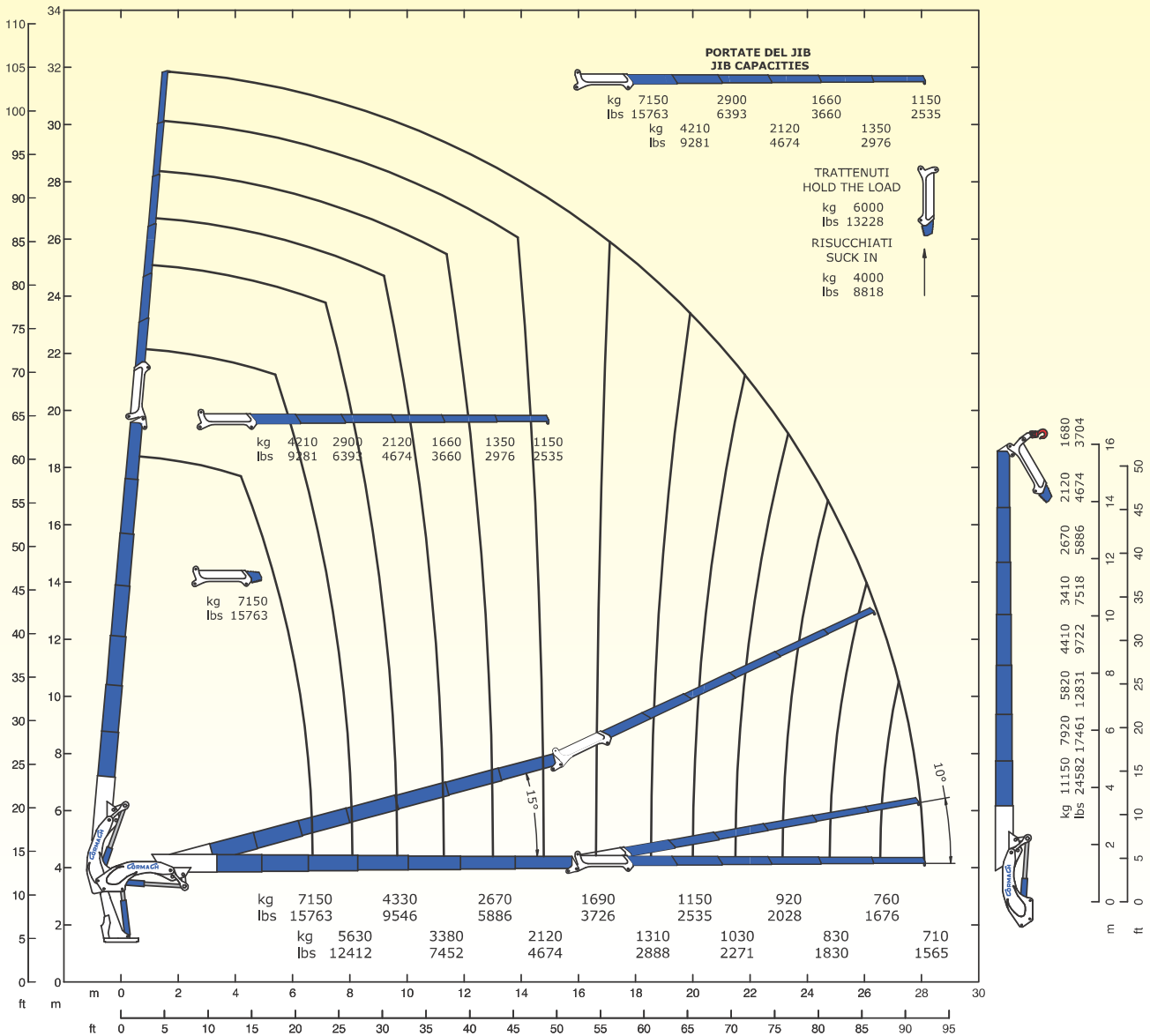

E7F186	E7F186	
71200 daN*m	515089 Lb*ft	Momento statico massimo al perno torretta – Max. static moment at the turret pin Moment statique max. a l'axe de la tourelle – Max. statisches ubmoment am kransaulenbolzen
28.35 m	93' 0"	Sbraccio idraulico – Hydraulic boom length Longueur du bras hydraulique – Hydraulic reichweite
		Sbraccio con prolunghe manuali – Boom length with manual extension Longueur du bras avec rallonges manuelles - Auslegerlänge
7100 daN*m	51364 Lb*ft	Coppia di rotazione – Slew torque – Moment de rotation – Drehmoment
90 sec 360°	90 sec 360°	Tempo di rotazione – Slewing speed – Temp de rotation – Schwenkgeschwindigkeit
3625+2875mm	11' 11" + 9' 5"	Uscita stabilizzatori – Outriggers extension – Sortie de bequilles – Breite der Abstützung
8850 mm	29' 0"	Larghezza stabilizzatori – Outriggers width – Largeur des bequilles – Gesamtbreite der Abstützung
1645 mm	5' 5"	Lunghezza – Length – Longueur – Gesamtbreite
2550 mm	8' 4"	Larghezza – Width – Largeur - Breite
2940 mm	9' 8"	Altezza – Height – Hauteur - Höhe
8616 kg	18995 lbs	Peso (senza olio e montaggio) – Weight (without oil and fitting) Poids (sans huile et montage – Gewicht (ohne Öl und ohne)
100 l/min	26 us gal/min	Portata pompa – Pump delivery – Capacité de la pompe - Pumpenleistung
320 bar	4550 psi	Pressione (*) – Pressure (*) – Pression (*) - Druck (*)
235 l	62 us gal	Capacità serbatoio olio – Oil tank capacity – Capacité du réservoir de l'huile – Öl tank inhalt

STANDARD

- Icon 1: Crane with A.S.C. Plus logo
- Icon 2: Crane with A.S.C. Plus logo
- Icon 3: Crane with A.S.C. Plus logo
- Icon 4: Crane with A.S.C. Plus logo
- Icon 5: Crane with A.S.C. Plus logo
- Icon 6: Crane with A.S.C. Plus logo
- Icon 7: Crane with A.S.C. Plus logo
- Icon 8: Crane with A.S.C. Plus logo

OPTIONAL

- Icon 1: Crane with A.S.C. Plus logo
- Icon 2: Crane with A.S.C. Plus logo
- Icon 3: Crane with A.S.C. Plus logo
- Icon 4: Crane with A.S.C. Plus logo
- Icon 5: Crane with A.S.C. Plus logo
- Icon 6: Crane with A.S.C. Plus logo
- Icon 7: Crane with A.S.C. Plus logo
- Icon 8: Crane with A.S.C. Plus logo

(*) Consigliata, (*) Recommended, (*) Reconnué, (*) Empfohlen.

71000 E7F186

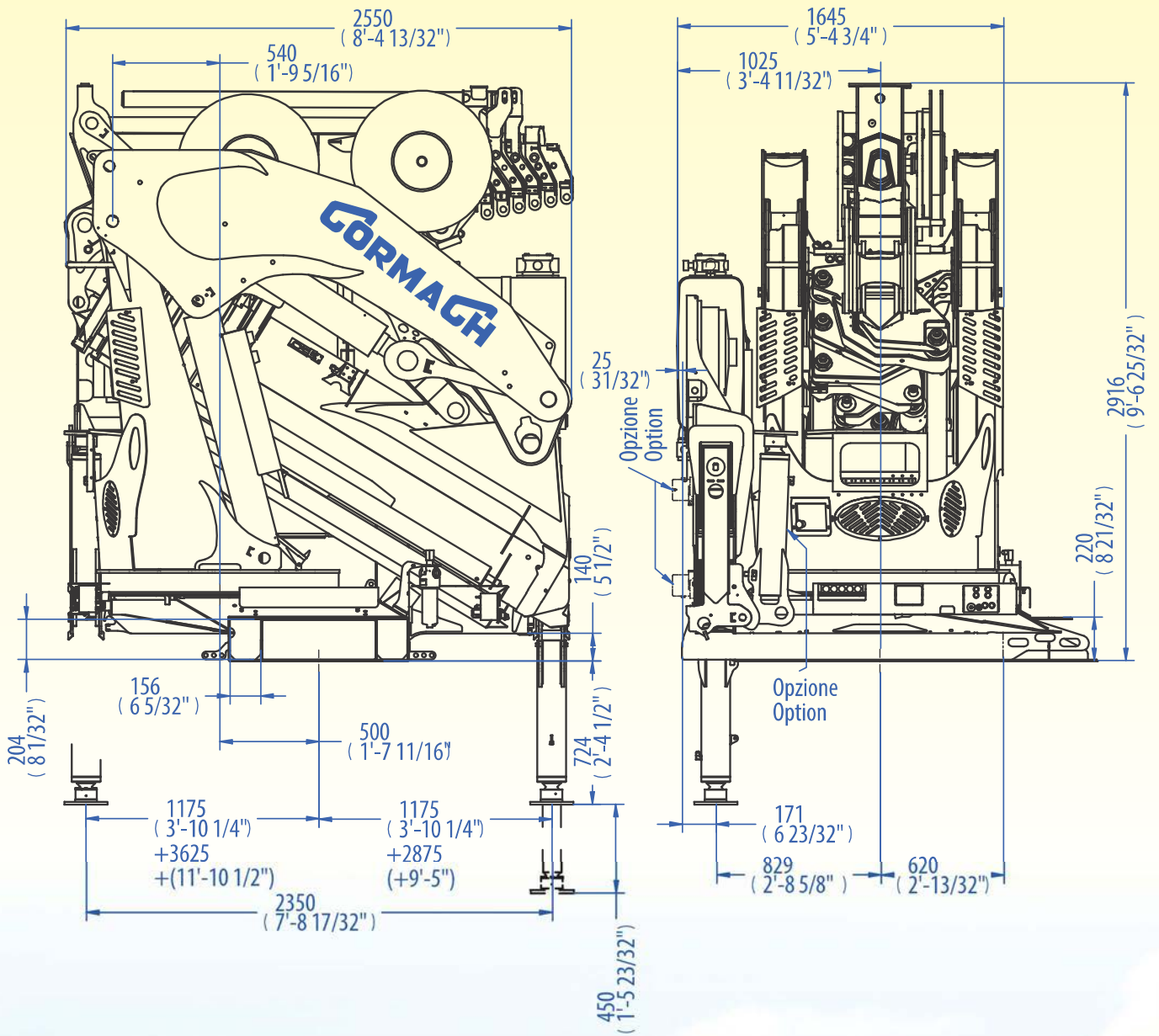

71000 E A.S.C. Plus

71000 E9F132

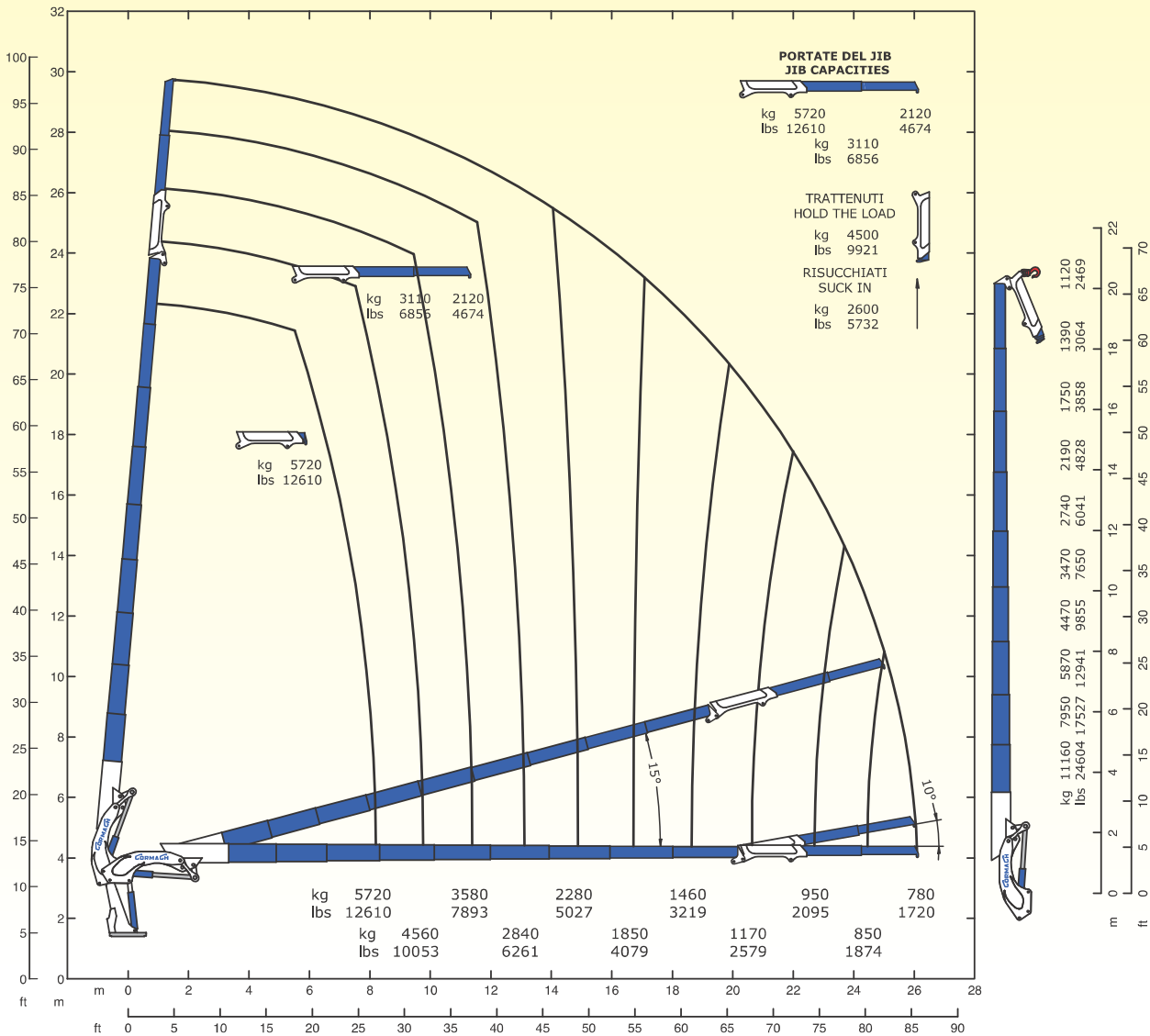

E9F132	E9F132	
71200 daN*m	515089 Lb*ft	Momento statico massimo al perno torretta – Max. static moment at the turret pin Moment statique max. a l'axe de la tourelle – Max. statisches ubmoment am kransaulenbolzen
26.05 m	85' 6"	Sbraccio idraulico – Hydraulic boom length Longueur du bras hydraulique – Hydraulic reichweite
		Sbraccio con prolunghe manuali – Boom length with manual extension Longueur du bras avec rallonges manuelles – Auslegerlänge
7100 daN*m	51364 Lb*ft	Coppia di rotazione – Slew torque – Moment de rotation – Drehmoment
90 sec 360°	90 sec 360°	Tempo di rotazione – Slewing speed – Temp de rotation – Schwenkgeschwindigkeit
3625+2875mm	11' 11"+9' 5"	Uscita stabilizzatori – Outriggers extension – Sortie de bequilles – Breite der Abstützung
8850 mm	29' 0"	Larghezza stabilizzatori – Outriggers width – Largeur des bequilles – Gesamtbreite der Abstützung
1645 mm	5' 5"	Lunghezza – Length – Longueur – Gesamtbreite
2550 mm	8' 4"	Larghezza – Width – Largeur – Breite
2910 mm	9' 7"	Altezza – Height – Hauteur – Höhe
8545 kg	18839 lbs	Peso (senza olio e montaggio) – Weight (without oil and fitting) Poids (sans huile et montage – Gewicht (ohne Öl und ohne)
100 l/min	26 us gal/min	Portata pompa – Pump delivery – Capacité de la pompe – Pumpenleistung
320 bar	4550 psi	Pressione (*) – Pressure (*) – Pression (*) – Druck (*)
235 l	62 us gal	Capacità serbatoio olio – Oil tank capacity – Capacité du réservoir de l'huile – Öl tank inhalt

STANDARD

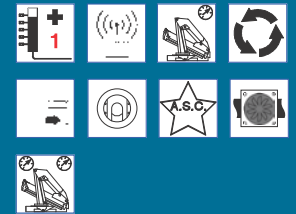

OPTIONAL

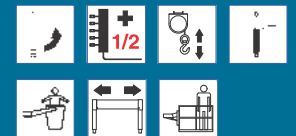

(*) Consigliata, (*) Recommended, (*) Reconnandé, (*) Empfohlen.

71000 E9F133

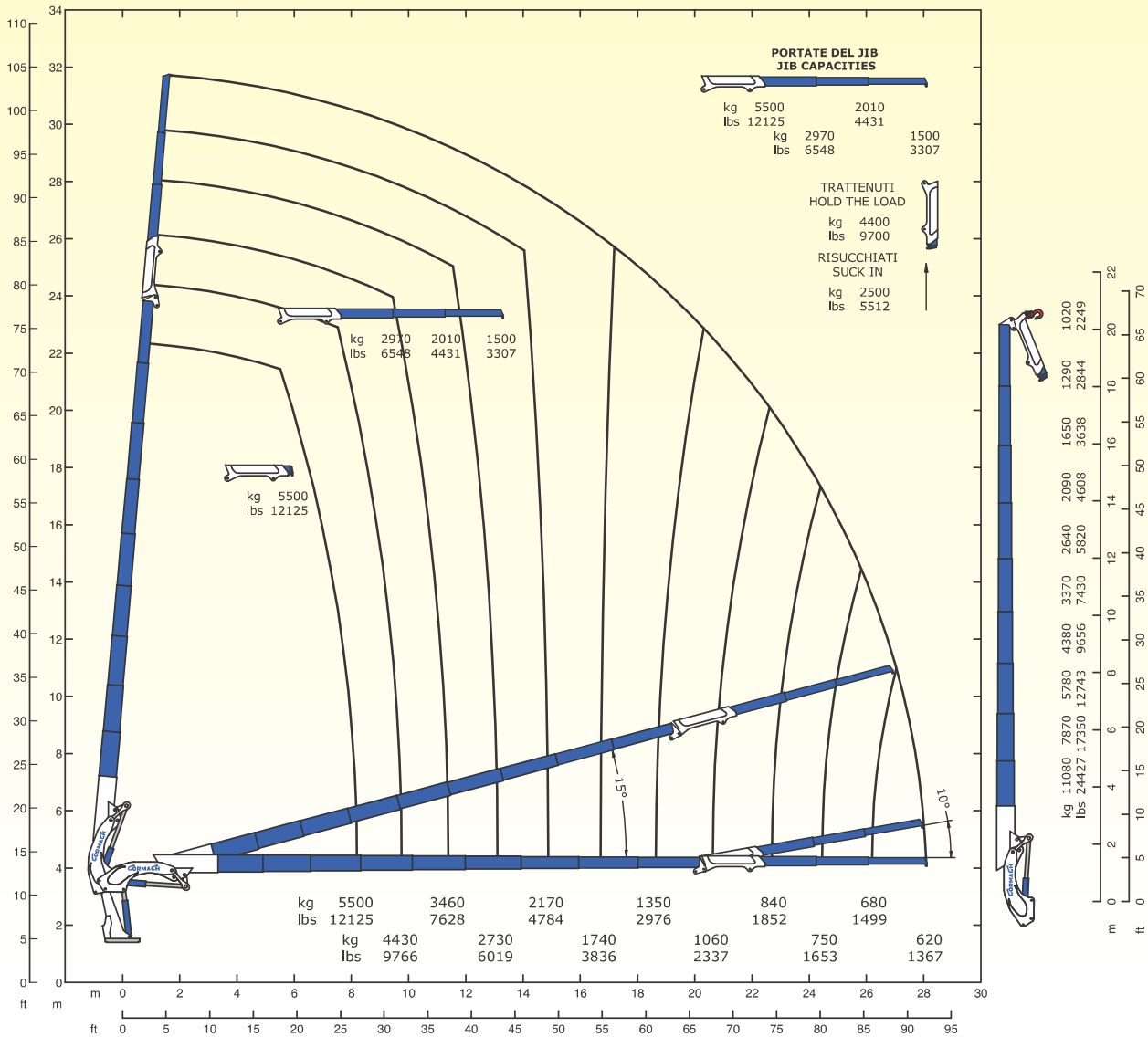

E9F133	E9F133	
71200 daN*m	515089 Lb*ft	Momento statico massimo al perno torretta – Max. static moment at the turret pin Moment statique max. a l'axe de la tourelle – Max. statisches ubmoment am kransaulenbolzen
28.04 m	92' 0"	Sbraccio idraulico – Hydraulic boom length Longueur du bras hydraulique – Hydraulic reichweite
		Sbraccio con prolunghe manuali – Boom length with manual extension Longueur du bras avec rallonges manuelles - Auslegerlänge
7100 daN*m	51364 Lb*ft	Coppia di rotazione – Slew torque – Moment de rotation – Drehmoment
90 sec 360°	90 sec 360°	Tempo di rotazione – Slewing speed – Temp de rotation – Schwenkgeschwindigkeit
3625+2875mm	11' 11" + 9' 5"	Uscita stabilizzatori – Outriggers extension – Sortie de bequilles – Breite der Abstützung
8850 mm	29' 0"	Larghezza stabilizzatori – Outriggers width – Largeur des bequilles – Gesamtbreite der Abstützung
1645 mm	5' 5"	Lunghezza – Length – Longueur – Gesamtbreite
2550 mm	8' 4"	Larghezza – Width – Largeur - Breite
2910 mm	9' 7"	Altezza – Height – Hauteur – Höhe
8652 kg	19074 lbs	Peso (senza olio e montaggio) – Weight (without oil and fitting) Poids (sans huile et montage – Gewicht (ohne Öl und ohne)
100 l/min	26 us gal/min	Portata pompa – Pump delivery – Capacité de la pompe - Pumpenleistung
320 bar	4550 psi	Pressione (*) – Pressure (*) – Pression (*) - Druck (*)
235 l	62 us gal	Capacità serbatoio olio – Oil tank capacity – Capacité du réservoir de l'huile – Öl tank inhalt

STANDARD

-
-
-
-
-
-
-

OPTIONAL

-
-
-
-
-
-

(*) Consigliata, (*) Recommended, (*) Reconnmandé, (*) Empfohlen.

71000 E A.S.C. Plus

71000 E9F134

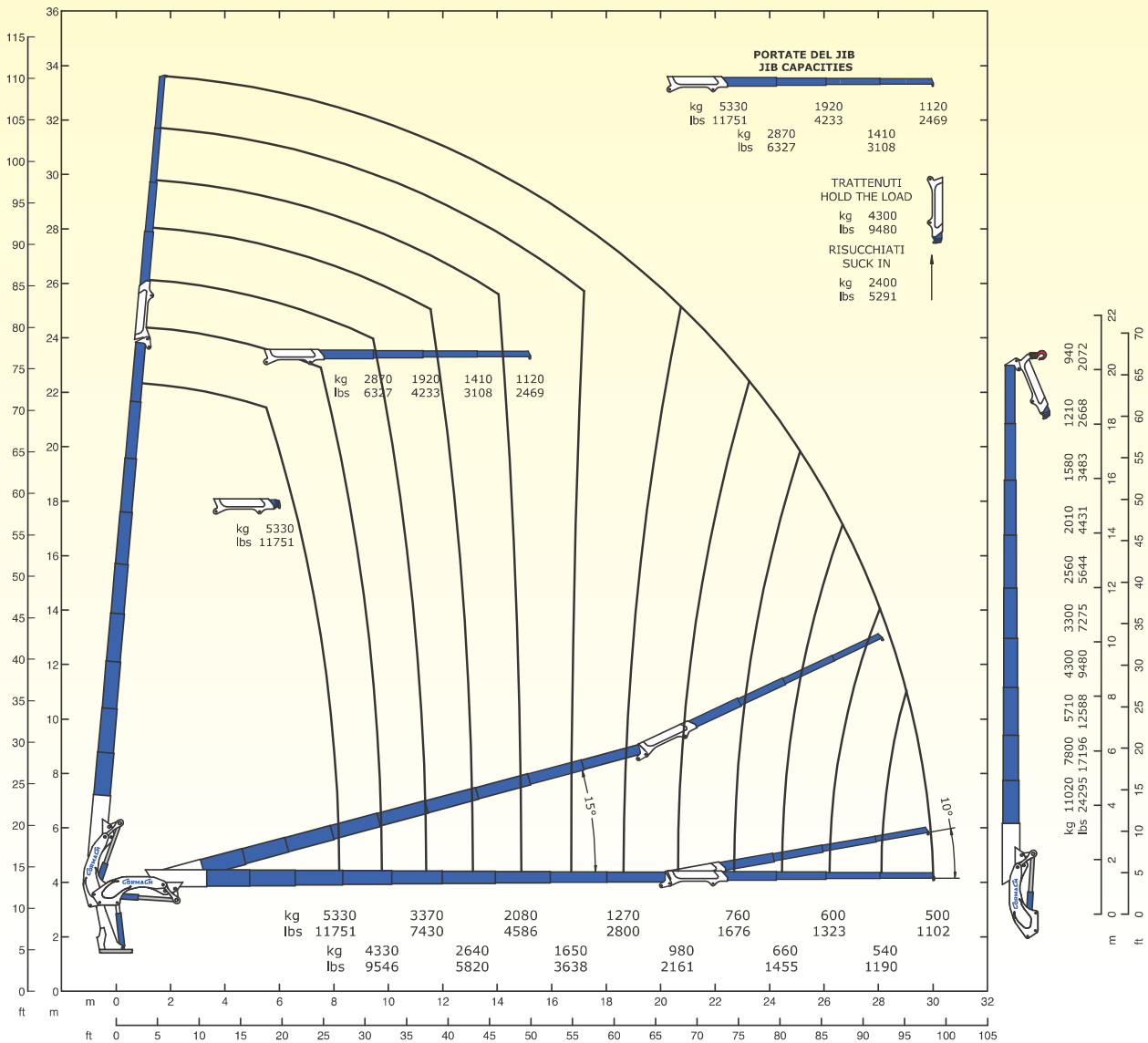

E9F134	E9F134	
71200 daN*m	515089 Lb*ft	Momento statico massimo al perno torretta – Max. static moment at the turret pin Moment statique max. a l'axe de la tourelle – Max. statisches ubmoment am kransaulenbolzen
30.00 m	98' 5"	Sbraccio idraulico – Hydraulic boom length Longueur du bras hydraulique – Hydraulic reichweite
		Sbraccio con prolunghe manuali – Boom length with manual extension Longueur du bras avec rallonges manuelles – Auslegerlänge
7100 daN*m	51364 Lb*ft	Coppia di rotazione – Slew torque – Moment de rotation – Drehmoment
90 sec 360°	90 sec 360°	Tempo di rotazione – Slewing speed – Temp de rotation – Schwenkgeschwindigkeit
3625+2875mm	11' 11"+9' 5"	Uscita stabilizzatori – Outriggers extension – Sortie de bequilles – Breite der Abstützung
8850 mm	29' 0"	Larghezza stabilizzatori – Outriggers width – Largeur des bequilles – Gesamtbreite der Abstützung
1645 mm	5' 5"	Lunghezza – Length – Longueur – Gesamtbreite
2550 mm	8' 4"	Larghezza – Width – Largeur – Breite
2910 mm	9' 7"	Altezza – Height – Hauteur – Höhe
8738 kg	19264 lbs	Peso (senza olio e montaggio) – Weight (without oil and fitting) Poids (sans huile et montage – Gewicht (ohne Öl und ohne)
100 l/min	26 us gal/min	Portata pompa – Pump delivery – Capacité de la pompe – Pumpenleistung
320 bar	4550 psi	Pressione (*) – Pressure (*) – Pression (*) – Druck (*)
235 l	62 us gal	Capacità serbatoio olio – Oil tank capacity – Capacité du réservoir de l'huile – Öl tank inhalt

STANDARD

- 1
- AS.C.

OPTIONAL

- 1/2

(*) Consigliata, (*) Recommended, (*) Reconnandé, (*) Empfohlen.

71000 E9F134

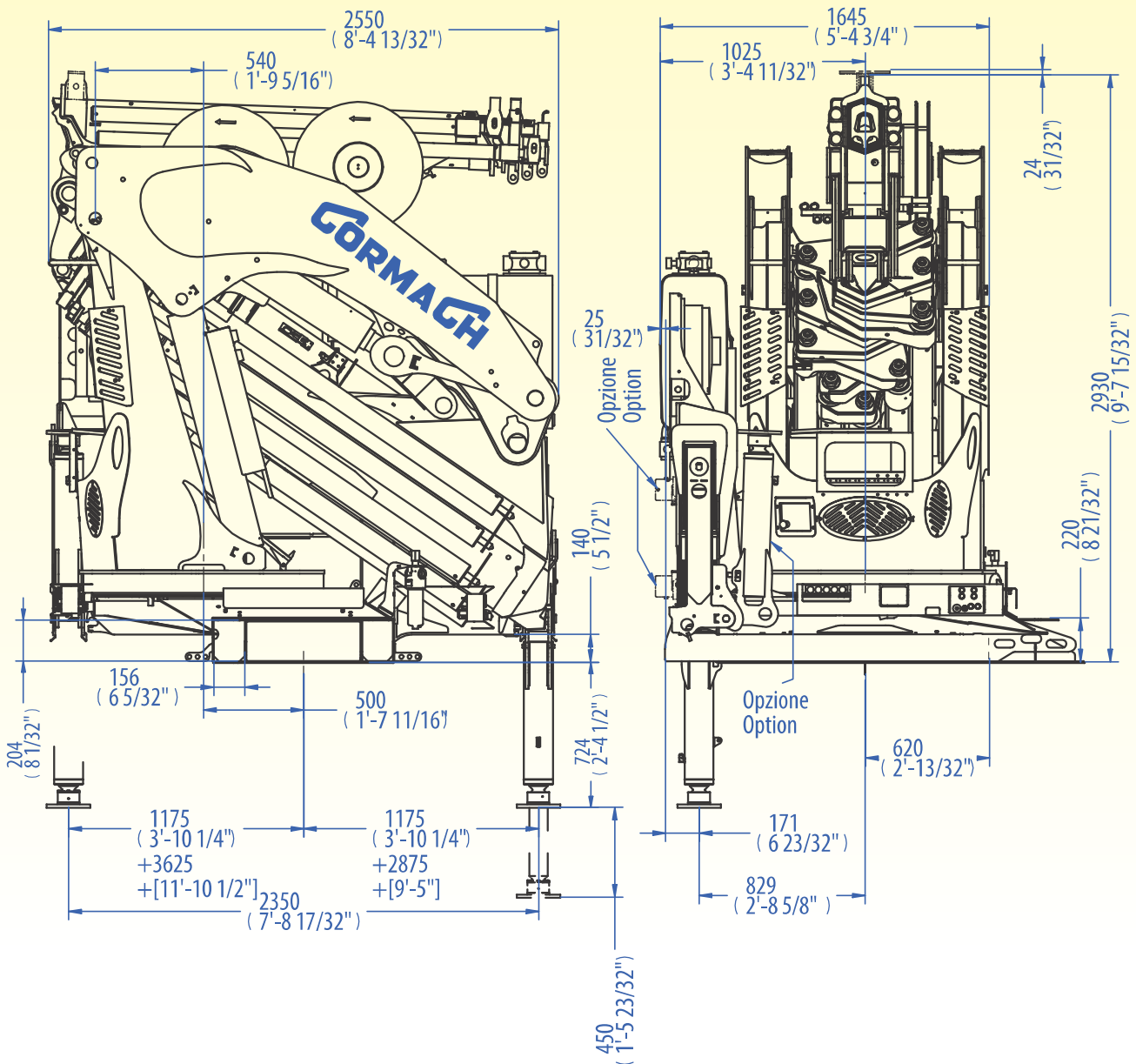

STANDARD

 **Comando supplementare non attivato (1)**
Additional free section not activated (1)
Section du distributeur pas activé (1)
Zusätzlicher steuerschieber (1)

 **Radiocomando**
Radio remote control
Radiocommandes
Funkfernsteuerung

 **Limitatore di momento**
Load limiting device
Limiteur de charge
Überlastabschal tungssystem

 **Rotazione continua**
Continuous rotation
Rotation continue
Endlos schwenkwerk

 **Stabilizzatori gru base estendibili idraulicamente**
Outriggers with hydraulic
Stabilisateurs avec extension hydraulique
Hydraulisch ausfahrbare stützen

 **Piastre di appoggio maggiorate**
Large ground plates
Plaques stabilisateurs
Bodenplatten

 **Automatic Speed Control**
Automatic Speed Control
Automatic Speed Control
Automatic Speed Control

 **Scambiatore di calore**
Oil cooler
Echangeur de chaleur
Ölkühler

 **Doppio limitatore di momento**
Double load limiting device
Double limiteur de charge
Doppel Überlastabschal tungssystem

OPTIONAL

 **Stabilizzatori gru base girevoli**
Tilt up outriggers
Bequilles tournants
Drehbare stützen

 **Comando supplementare attivato (1/2)**
Additional function (1/2)
Section du distributeur activée (1/2)
Zusatzfunktion (1/2)

 **Verricello**
Winch
Treuil
Seilwinde

 **Trattamento marino della gru**
Marine treatment of the crane
Traitement marine de la grue
Marine behandlung des kranes

 **Cestello**
Basket
Nacelle
Personnenkorb

 **Traversa ausiliaria estendibile**
Additional outriggers with lateral extension
Stabilisateurs supplementaires avec elargissement
Ausfahrbare zusatz- stützen

 **Piattaforma autolivellante**
Self leveling platform
Plateforme auto nivelante
Arbeitskorb mit automatische Ausgleich Analoge

71000 E A.S.C. Plus

E2		E3		E4		E5		E6		E7		E8		E9		E11	
m/ft	kg/lbs	m/ft	kg/lbs	m/ft	kg/lbs	m/ft	kg/lbs	m/ft	kg/lbs	m/ft	kg/lbs	m/ft	kg/lbs	m/ft	kg/lbs	m/ft	kg/lbs
3.60	16000	3.72	15340	3.80	14850	3.89	14400	4.00	13840	4.28	12850	4.17	13020	4.33	12410	4.40	12020
11'10"	35274	12'2"	33819	12'6"	32738	12'9"	31747	13'1"	30512	14'1"	28329	13'8"	28704	14'2"	27359	14'5"	26500
5.07	11650	5.19	11180	5.28	10820	5.36	10470	5.48	10070	5.76	9420	5.64	9450	5.81	9010	5.88	8698
16'8"	25684	17'0"	24648	17'4"	23854	17'7"	23082	18'0"	22200	18'11"	20768	18'6"	20834	19'1"	19864	19'4"	19158
6.64	9050	6.76	8660	6.85	8350	6.93	8050	7.05	7730	7.33	7240	7.21	7180	7.38	6850	7.45	6550
21'9"	19952	22'2"	19092	22'6"	18408	22'9"	17747	23'2"	17042	24'1"	15961	23'8"	15829	24'2"	15102	24'5"	14440
		8.39	7030	8.48	6750	8.56	6480	8.68	6190	8.96	5790	8.84	5700	9.01	5400	9.08	5110
		27'6"	15499	27'10"	14881	28'1"	14286	28'6"	13647	29'5"	12765	29'0"	12566	29'6"	11905	29'9"	11266
				10.20	5640	10.28	5380	10.40	5110	10.65	4780	10.53	4630	10.70	4370	10.77	4090
				33'6"	12434	33'9"	11861	34'1"	11266	34'11"	10538	34'7"	10207	35'1"	9634	35'4"	9017
						12.05	4600	12.17	4330	12.42	4030	12.30	3870	12.47	3620	12.54	3350
						39'6"	10141	40'0"	9546	40'9"	8885	40'4"	8532	40'11"	7981	41'2"	7385
								14.00	3760	14.25	3470	14.14	3300	14.30	3070	14.37	2790
								46'0"	8289	46'9"	7650	46'5"	7275	46'11"	6768	47'2"	6151
										16.17	3020	16.06	2850	16.23	2620	16.30	2350
										53'1"	6658	52'8"	6283	53'3"	5776	53'6"	5181
												18.06	2480	18.22	2250	18.29	1980
												59'3"	5467	59'9"	4960	60'0"	4365
														20.30	2000	20.36	1700
														66'7"	4409	66'10"	3748
																22.43	1500
																73'7"	3307
																24.50	1360
																80'5"	2998



71000 E7F186 A.S.C. Plus

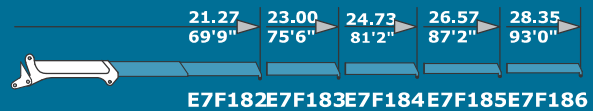

E7F182E7F183E7F184E7F185E7F186

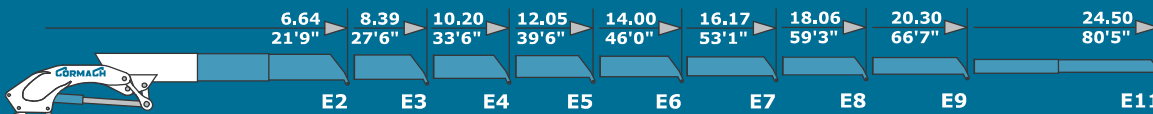

71000 E A.S.C. Plus

E2 E3 E4 E5 E6 E7 E8 E9 E11

71000 E9F134 A.S.C. Plus

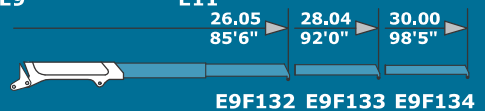

E9F132 E9F133 E9F134

E7F182		E7F183		E7F184		E7F185		E7F186		E9F132		E9F133		E9F134	
m/ft	kg/lbs	m/ft	kg/lbs	m/ft	kg/lbs	m/ft	kg/lbs	m/ft	kg/lbs	m/ft	kg/lbs	m/ft	kg/lbs	m/ft	kg/lbs
6.43	8100	6.50	7910	6.60	7700	6.70	7370	6.80	7150	8.08	5720	8.15	5500	8.20	5330
21'1"	17857	21'4"	17439	21'8"	16976	22'0"	16248	22'4"	15763	26'7"	12610	26'7"	12125	26'9"	11751
7.90	6200	7.98	6040	8.06	5880	8.14	5740	8.19	5630	9.65	4560	9.71	4430	9.76	4330
25'11"	13669	26'3"	13316	26'6"	12963	26'9"	12655	26'10"	12412	31'8"	10053	31'10"	9766	32'0"	9546
9.47	4840	9.55	4700	9.63	4550	9.71	4430	9.76	4330	11.28	3580	11.35	3460	11.40	3370
31'1"	10670	31'4"	10362	31'8"	10031	31'11"	9766	32'0"	9546	37'0"	7893	37'2"	7628	37'4"	7430
11.10	3850	11.18	3720	11.26	3590	11.34	3470	11.39	3380	12.96	2840	13.03	2730	13.08	2640
36'5"	8488	36'9"	8201	37'0"	7915	37'3"	7650	37'4"	7452	42'6"	6261	42'9"	6019	42'11"	5820
12.79	3120	12.87	3000	12.95	2870	13.03	2760	13.08	2670	14.73	2280	14.80	2170	14.85	2080
42'0"	6878	42'3"	6614	42'6"	6327	42'9"	6085	42'11"	5886	48'4"	5027	48'6"	4784	48'8"	4586
14.56	2560	14.64	2430	14.72	2310	14.80	2210	14.85	2120	16.57	1850	16.64	1740	16.69	1650
47'9"	5644	48'1"	5357	48'4"	5093	48'7"	4872	48'9"	4674	54'4"	4079	54'6"	3836	54'8"	3638
16.40	2120	16.48	2000	16.56	1880	16.64	1780	16.69	1690	18.49	1460	18.56	1350	18.61	1270
53'10"	4674	54'1"	4409	54'4"	4145	54'7"	3924	54'9"	3726	60'8"	3219	60'11"	2976	61'1"	2800
18.32	1730	18.40	1610	18.48	1490	18.56	1400	18.61	1310	20.49	1170	20.56	1060	20.61	980
60'1"	3814	60'4"	3549	60'8"	3285	60'11"	3086	61'1"	2888	67'3"	2579	67'5"	2337	67'7"	2161
19.78	1570	19.86	1450	19.94	1340	20.02	1240	20.07	1150	22.55	950	22.62	840	22.67	760
64'11"	3461	65'2"	3197	65'5"	2954	65'8"	2734	65'10"	2535	74'0"	2095	74'3"	1852	74'5"	1676
21.27	1440	21.35	1320	21.43	1210	21.51	1110	21.56	1030	24.30	850	24.37	750	24.42	660
69'9"	3176	70'1"	2910	70'4"	2668	70'7"	2447	70'9"	2271	79'9"	1874	80'0"	1653	80'2"	1455
		23.00	1210	23.08	1100	23.16	1000	23.21	920	26.05	780	26.12	680	26.17	600
		75'6"	2668	75'9"	2425	76'0"	2205	76'2"	2028	85'6"	1720	85'8"	1499	85'10"	1323
				24.73	1010	24.81	920	24.86	830			28.04	620	28.09	540
				81'2"	2227	81'5"	2028	81'7"	1830			92'0"	1367	92'2"	1190
						26.57	850	26.62	760					30.00	500
						87'2"	1874	87'4"	1676					98'5"	1102
								28.35	710						
								93'0"	1565						

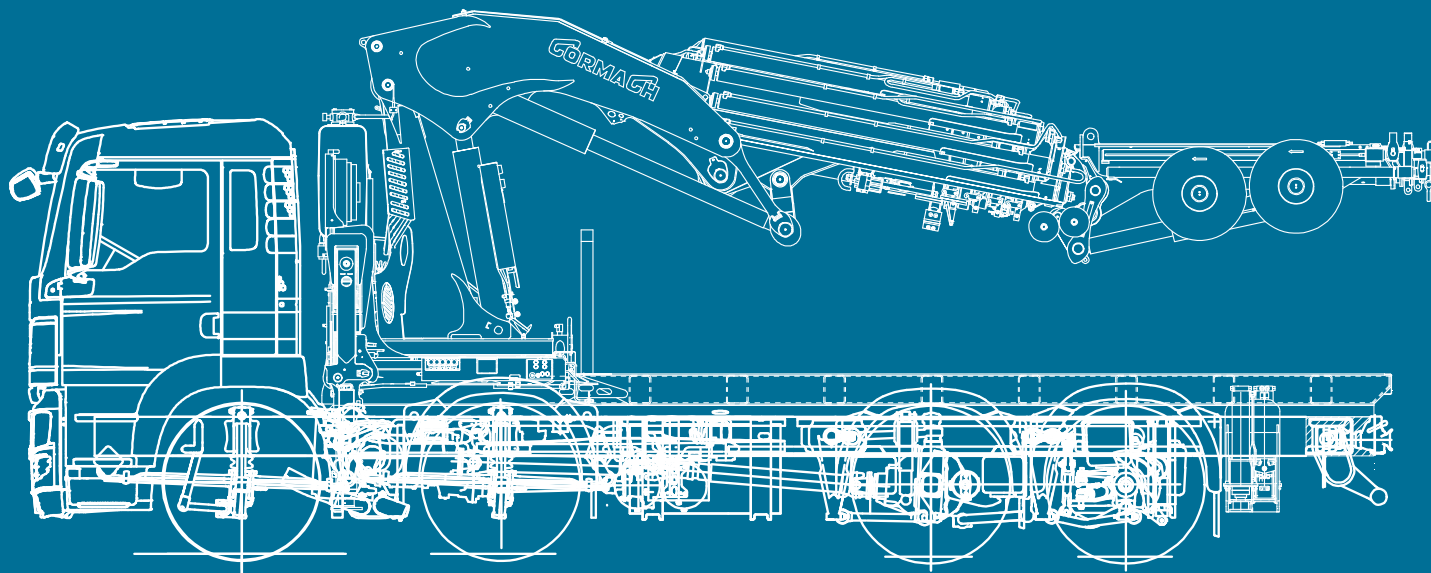



CORMACH

Cormach s.r.l. - Via Madonnina, 27 - C.P. 199 - 25018 MONTICHIARI (BS) - ITALY
Tel. 0039.030.9656811 - Telefax 0039.030.9656846.7.8
E-mail: info@cormach.com - www.cormach.com

A fronte di una continua ricerca tecnologica i dati possono cambiare senza preavviso. Contattare il nostro Ufficio Commerciale per ulteriori informazioni.
Because of continuous technology research data can change without notice. Please, contact our Commercial Dept. for further information.
A cause de une continue recherche technologique les données peuvent changer sans preavis. Contacter notre Bureau Commercial pour des autres informations.
Irtum und technische Änderung vorbehalten masse und gewichte unverbindlich. Unser Vertrieb erteilt Ihnen gerne weitere Auskünfte. Bitte rufen Sie uns an.
Debito a los continuos avances tecnológicos los datos pueden variar sin notificación previa. Para más información rogamos contacten nuestro Departamento Comercial.